

INSTRUCTIONS

MODELS **CHS/CHT** **BIOLOGICAL MICROSCOPES**

*scanned by J. G. McHone, 15 Feb 2009
for personal information, not for sale*

WARNING

This instruction manual is for use of the Olympus Biological Microscopes Models CHS & CHT. We recommend you read this manual carefully in order to familiarize yourself fully with the use of your microscope so that you can obtain optimum performance.

OLYMPUS



AX5571

BEFORE USE

Observe the following procedures carefully:

1 Operation

- ① Since the microscope is a precision instrument, always handle it with care, and avoid **abrupt** motions or shocks.
 - ② Avoid exposure to **direct sunlight, high temperature and humidity, dust and vibration.**
 - ③ Before bulb or fuse replacement, **unplug** the power cord from the AC outlet.
 - ④ Always **ground** the microscope to prevent electric hazard.
 - ⑤ Only use the **tension adjustment ring** for altering the tension of the coarse adjustment knobs.
 - ⑥ Be careful **not** to soil lens surfaces with dust, fingerprints, etc.
 - ⑦ Be certain the voltage selector switch on the base plate of the microscope is set to conform with the local line voltage before use. (CHS only)
- ★ Specifications of the electrical components differ from others than the equipment with 120 V of supply circuit, as the equipment is in compliance with the requirements of Underwriters Laboratories. Also, the equipment is not needed to select voltage.

2 Maintenance and Storage

- ① Use a clean brush or lens tissue paper to clean the lens surfaces. If the lens surfaces are soiled with oil or fingerprints, wipe them off carefully with gauze moistened with a **small** amount of a cleaning medium (alcohol and ether 3:7), or xylene.
- ② Do not use organic solutions (e.g. thinner, xylene, ether, alcohol) to wipe painted surfaces or plastic parts of various components. They should be cleaned with a **neutral** detergent.
- ③ **Never disassemble** each component of the microscope for repair yourself, since the integrated performance may be impaired.
- ④ When not in use, the microscope should be covered with the dust cover provided or contained in a storage case, and kept in a place free from humidity and mold.

Assembly of the microscope fixing blocks inside the wooden storage case (CHS-WB/CHT-WB) (optionally available)

Install two blocks at the bottom of the wooden case in the following procedure:

- 1) Insert one of the two screws into a flat washer and one of the two holes (8mm dia.) as illustrated at the right.
- 2) Insert the screw into the block from below, and clamp with the spanner provided.
- 3) Clamp the other block with the other screw on the opposite side in the same manner as mentioned above.

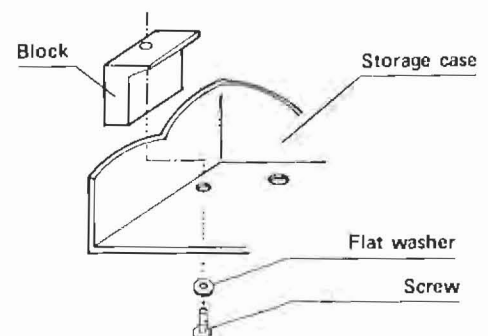

CONTENTS

1. STANDARD CONFIGURATIONS	1	1
2. SPECIFICATIONS	2	2
3. NOMENCLATURE	3	3
4. ASSEMBLY	5	4
4-1 Assembly Diagram	5	
4-2 Explanation for Assembly Procedure	6	
5. OBSERVATION (Putting the Microscope in Operation)	9	5
1 Switching on the Bulb	9	
2 Specimen Placement	9	
3 Focus	10	
4 Interpupillary Distance Adjustment	10	
5 Diopter Adjustment	11	
6 Centration of the Field Iris Diaphragm CH2-FS (optional)	11	
7 Objective Change	11	
8 Adjustment of the Aperture Iris Diaphragm	12	
9 Adjustment of the Field Iris Diaphragm (for CH2-FS only)	12	
10 Tension Adjustment of the Coarse Adjustment Knobs	12	
11 Locking of the Pre-focusing Lever	13	
12 Use of Immersion Objectives	13	
6. PHOTOMICROGRAPHY	14	6
6-1 System Diagram of Photomicrographic Equipment (optionally available)	14	
6-2 Setup of the Photomicrographic Equipment	14	
6-3 Color Temperature Regulation (for use of daylight type color film)	15	
7. OPTICAL DATA	16	7
8. TROUBLESHOOTING GUIDE	17	8

STANDARD CONFIGURATIONS

Component		CHS-213E	CHT-213E
Microscope stand with quadruple revolving nosepiece, square plain stage, low voltage illuminator base, including dust plug AA7808, filter 32.5C-2, immersion oil 8cc and dust cover CO11	CHS-F	○	
Microscope stand with quadruple revolving nosepiece, square plain stage, 30W illuminator base, including dust plug AA7808, filter 32.5C-2, immersion oil 8cc and dust cover CO11	CHT-F		○
Power cord	UYCP	○	○
Binocular observation tube, inclined 45°	CH-BI45-W	○	○
Attachable mechanical stage with right-hand low drive controls	CH-MVR	○	○
Condenser	CH2-CD	○	○
Filter holder	CH2-FH	○	○
6V 20W halogen bulb, 2 pcs.	6V 20W HAL	○	
30W tungsten bulb, 2 pcs.	30W SB		○
E D achromatic objective 4X	ED4X	○	○
E D achromatic objective 10X	ED10X	○	○
E D achromatic objective 40X (spring)	ED40X/R	○	○
E D achromatic objective 100X (spring, oil)	ED100X/RO	○	○
LB eyepiece 10X, 2 pcs.	CWHK10X	○	○

Note: ○ indicates the compatible components for each model.

Optional accessories:

Field iris diaphragm attachment	CH2-FS
Phase contrast attachment	CH2-PCD-PL
Simple phase contrast attachment	CH2-PC-PL
Simple polarizing attachment	CH2-POL SET
Dual viewing attachment	CH2-DO
Magnification changer	BH2-CA
Vertical illuminator	BH2-KMA
Dry darkfield condenser	BH-DCD
Immersion darkfield condenser	BH-DCW
Wooden storage case	CHS-/CHT-WB

2 SPECIFICATIONS

Item		Description
Microscope stand	Microscope limb	Circular dovetail mount for observation tube with accommodation to accept an analyzer; built-on quadruple nosepiece and plain stage 124 mm (X) x 153 mm (Y)
	Focus adjustments	Coaxial coarse and fine focusing controls within a focus adjustment range of 25 mm. Fine adjustment knobs graduated in increments of 2.5 μ . Tension adjustment ring for coarse adjustment knobs and pre-focusing lever for coarse focusing.
	Condenser holder	Rack and pinion condenser height displacement up to 28 mm.
	Base	Illuminators built-in bases: 6V 20W halogen bulb with transformer built-in CHS-F 110V/120V 30W tungsten bulb with reflector built-in CHT-F Light intensity variable by means of coil winding resistance. Mount at the light exit on the base for field iris diaphragm and 45 mm-dia. filter. Power cord is detachable.
Observation tube	Binocular	Inclined 45°; interpupillary distance adjustment with a scale between 53 mm and 72 mm. Left-side eyepiece tube equipped with diopter adjustment ring.
Mechanical stage		Low-positioned coaxial control knobs; X-Y traversing area 76 mm x 50 mm, compatible with two standard slides simultaneously.
Condenser		N.A. 1.25 (in immersion oil), with graduated aperture diaphragm. Provided with accommodation to accept a filter holder and an attachment lens for field iris diaphragm.
Filter holder		Accepts a 32.5 mm dia. filter.
Field iris diaphragm attachment (optionally available)	Iris diaphragm frame	Attachable on the light exit mount and accepts a 45 mm dia. filter. Diaphragm image can be formed in conjunction with objectives from 10X to 40X.
	Attachment lens	Attachable at the lower end of the condenser and accepts a 32.5 mm dia. filter; provided with centering screws for iris diaphragm.
Filter		Blue filter (32.5 mm dia.)
Objectives		ED4X, ED10X, ED40X (spring-loaded), and ED100X (spring-loaded, oil immersion)
Eyepiece		CWHK10X. Field No. 18; compatible with an eyepiece micrometer.
Dimensions		180 mm (W) x 223 mm (D) x 392 mm (H) (binocular version)
Eyepoint height		391 mm
Weight		CHS-213E: 6.2 kg (13.7 lb) CHT-213E: 5.8 kg (12.8 lb)
Power consumption (maximum)		CHS: 32 VA CHT: 32 VA

3 NOMENCLATURE

3

NOMENCLATURE

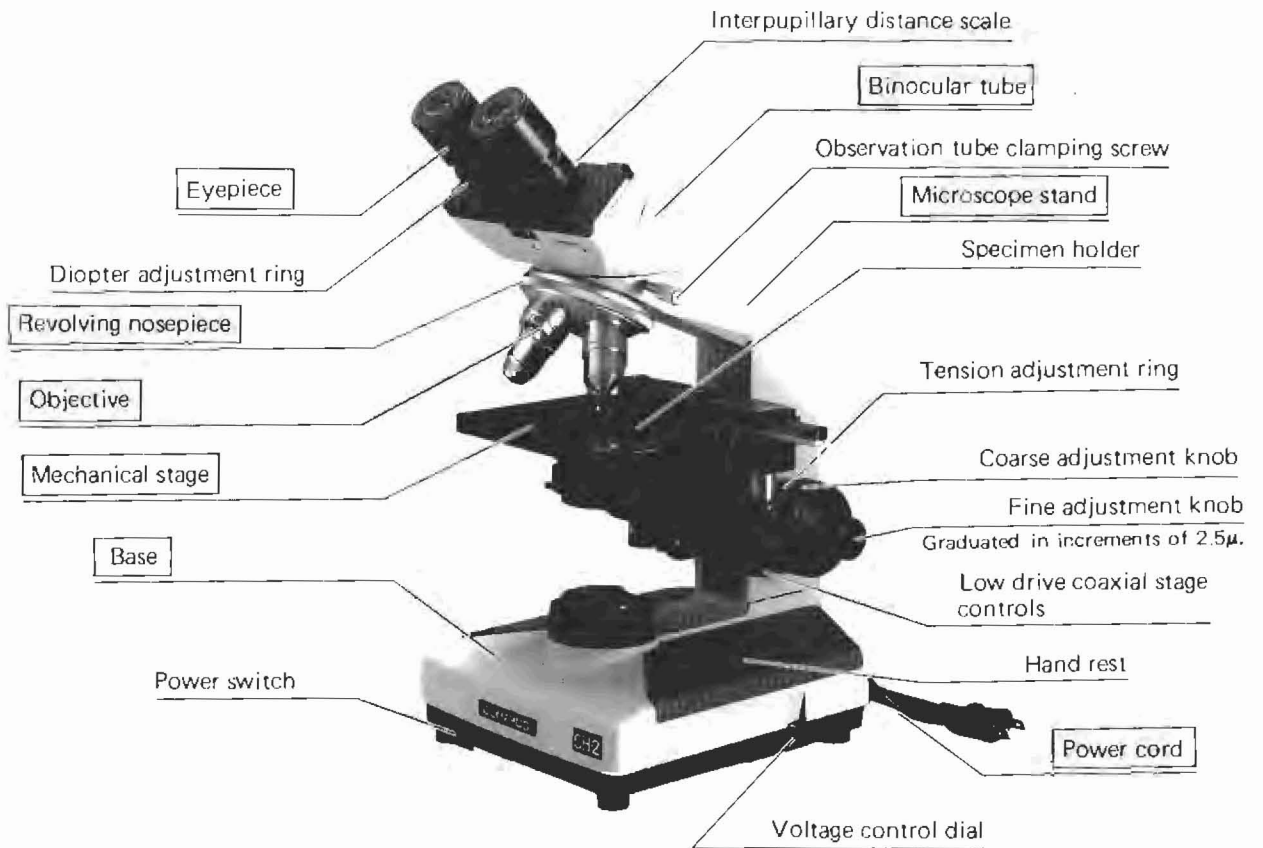

Field iris diaphragm attachment CH2-FS (optionally available)

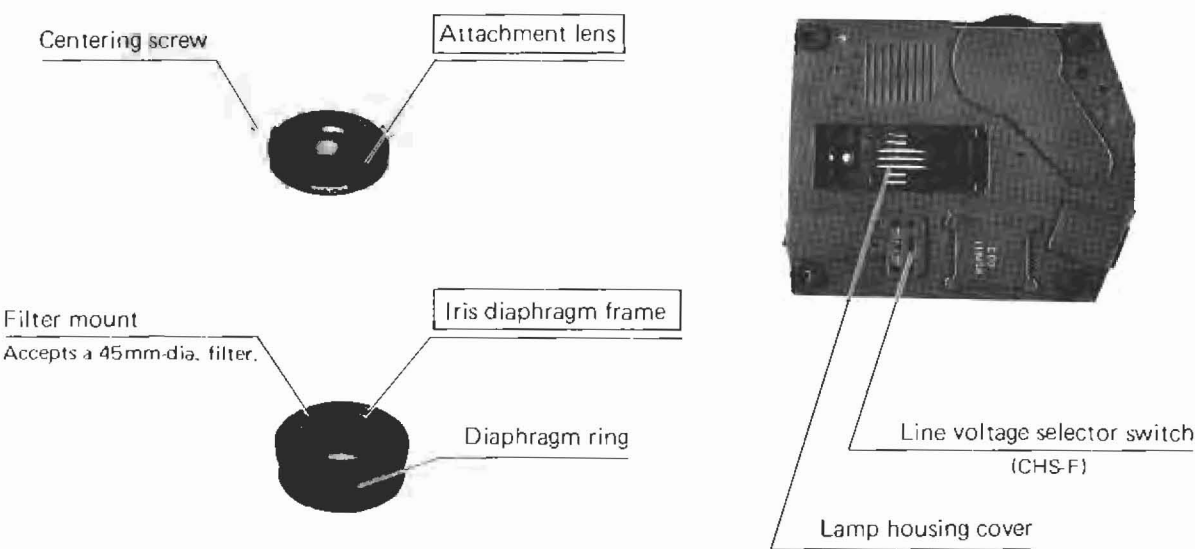

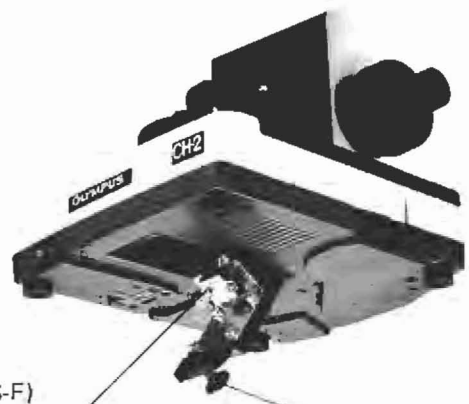
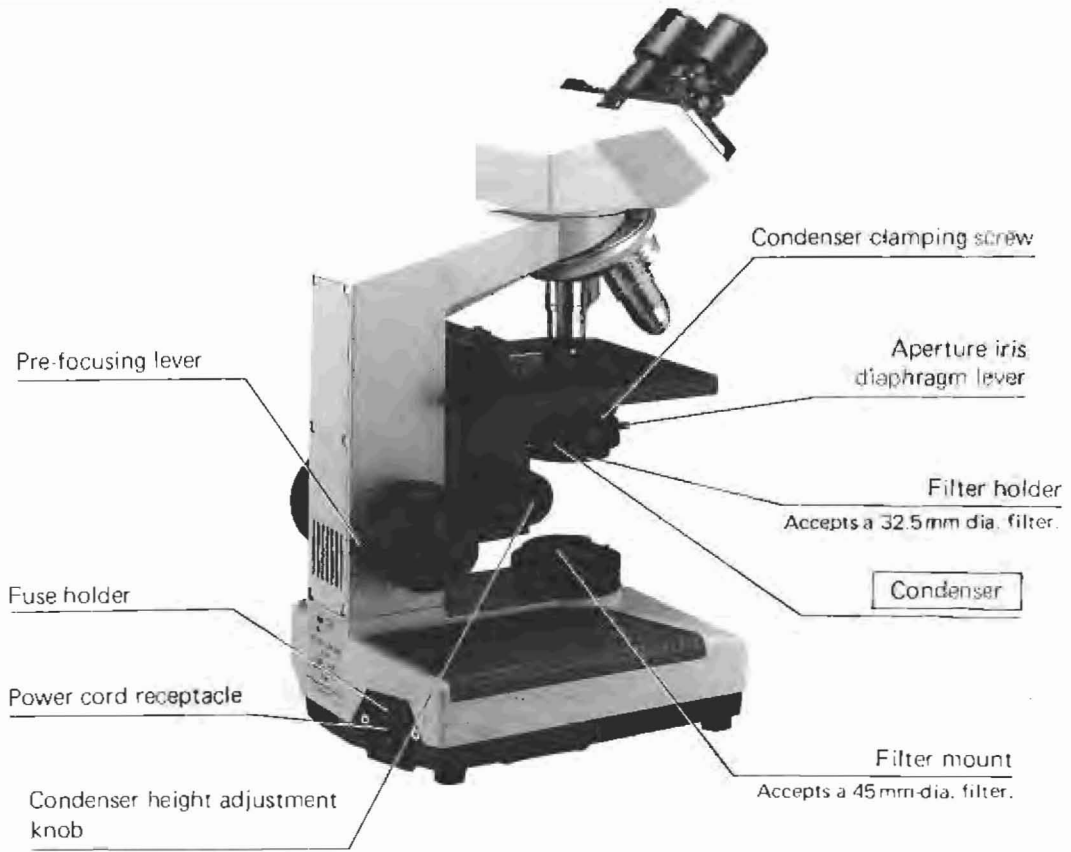
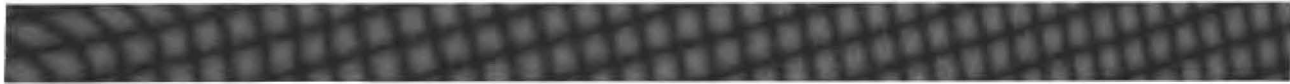

Bulb socket (CHS-F)
For 6V 20W halogen bulb.

Lamp housing knob

The lamp housing cover can be opened by pulling down the knob; or closed by pushing it up until it snaps in place.

Bulb socket (CHT-F)
For 110V/120V 30W tungsten bulb.



Before pushing the lamp housing cover, be certain the knob is positioned as shown in the picture left (marked with a circle).

4 ASSEMBLY

4-1 Assembly Diagram

- ★ Assemble each component in the order of the numbers with care to keep all glass surfaces clean and avoid scratching the lens surfaces.
- *Optional accessories

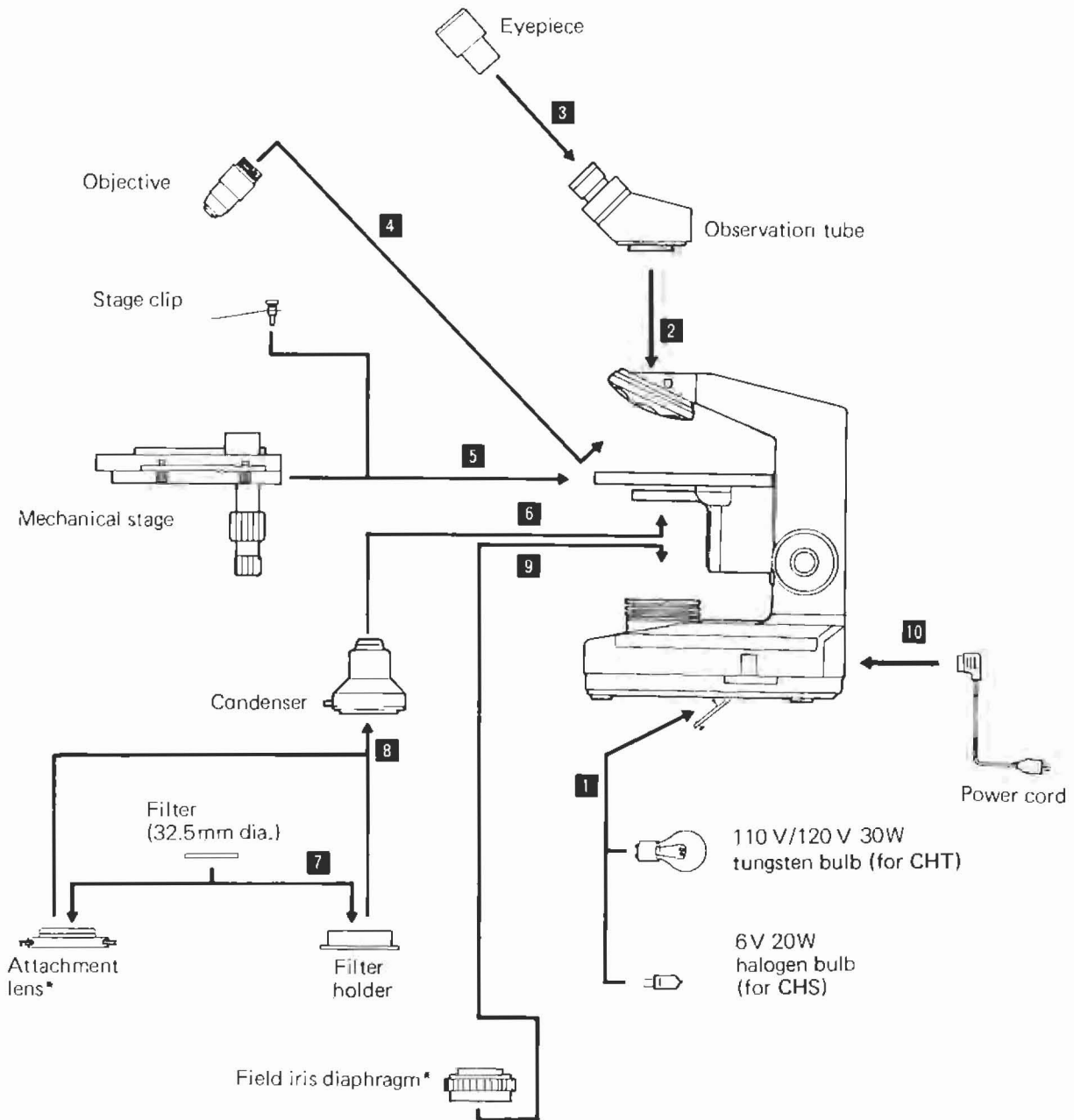

4-2 Explanation for Assembly Procedure



Fig. 1

Setting of the line voltage selector switch in position (for CHS only)

Ascertain that the line voltage selector switch ① is set in conformity with the local line voltage. If not, the switch should be set at 100V (for 110V to 120V) or 200V (for 220V to 240V) correctly by means of a screwdriver. (Fig. 1)

- ★ For the U.S.:
Frames sold in the U.S. meet the UL standard and are set at 115V. Therefore, this selector switch is not included.



Fig. 2

1 Bulb installation and replacement

1) Turn the microscope on its side and pull the lamp housing knob ① to open the lamp housing cover ②. (Fig. 2)

2) Install the bulb.

- 6V 20W halogen bulb (for CHS):
Hold the halogen bulb contained in a polyethylene bag to avoid leaving fingerprints on the bulb, and insert the contact pins into the bulb socket ③ all the way. (Fig. 2)



Fig. 3

- 110 V/120 V 30W tungsten bulb (for CHT):
Insert the tungsten bulb with its mirror portion ④ located at the lower side into the bulb socket ③; then, pressing it against the socket, rotate the bulb clockwise. (Fig. 3)

★ Before use, wipe off fingerprints or soils on the bulb.

★ 110 V bulb for local line voltage 110 V, and 120 V bulb for local line voltage 120 V or higher.

3) After bulb installation, close the lamp housing cover ②, pushing in the cover knob ①. (Fig. 3)

★ If the bulb burns out during observation, be certain to cool the defective bulb completely before replacement.



Fig. 4

2 Mounting the observation tube

1) Loosen the clamping screw ① fully, and mount the observation tube on the stand. Reclamp the screw ① to securely hold the observation tube on the stand. (Fig. 4)

2) The binocular tube is normally located in the direction of the microscope front, but it can be turned to any other direction, if necessary.

3 Eyepiece insertion

Insert the eyepieces into the eyepiece tubes ②. (Fig. 4)

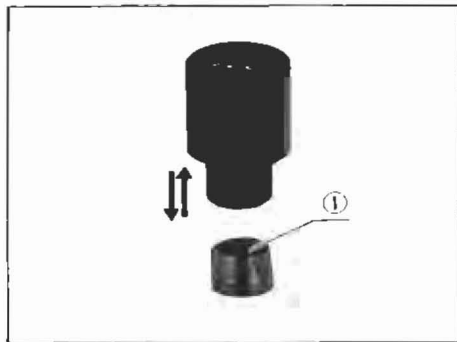

Fig. 5

Use of an eyepiece micrometer (19 mm in diameter)

An eyepiece micrometer (10 mm/100) (optionally available) can be inserted into the eyepiece CWHK10X in the following procedure:

- 1) Remove the retaining ring (1) from the lower end of the eyepiece and place the micrometer on the retaining ring with the reticle-engraved surface, facing downward. (Fig. 5)
 - ★ Be certain to clean the micrometer disc before inserting into the eyepiece.
- 2) Return the retaining ring into the eyepiece and insert the eyepiece into the eyepiece tube.

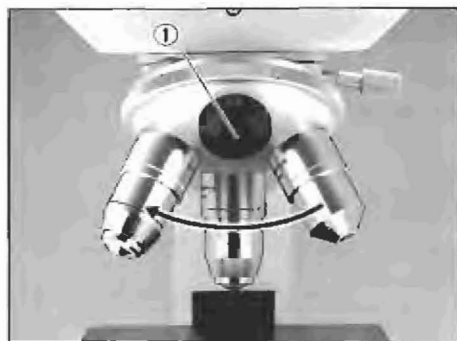

Fig. 6

4 Mounting the objectives

- 1) Lower the stage by means of the coarse adjustment knobs.
- 2) Screw the objectives into the nosepiece, from low power to higher power in a clockwise direction. (Fig. 6)
 - ★ Close the empty aperture in the nosepiece with a plug (1) provided. (Fig. 6)

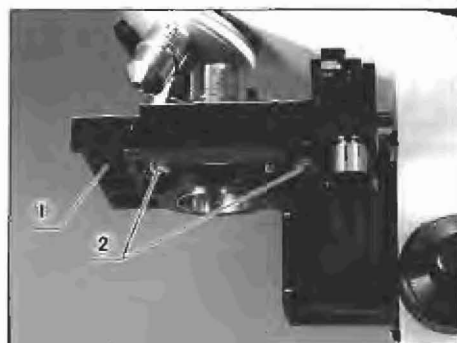

Fig. 7

5 Mounting the mechanical stage

Place the mechanical stage on the plain stage (1), with the specimen traversing guide closest to the microscope pillar, and tighten the stage clamping knobs (2) with a coin. (Fig. 7)

- Insertion of stage clips

The plain stage is pre-drilled for insertion of the stage clips when the mechanical stage is not attached (see page 4).

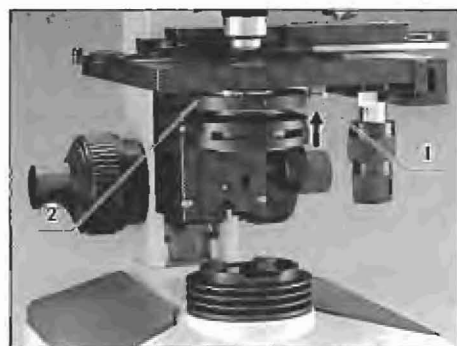

Fig. 8

6 Mounting the condenser

Insert the condenser into the condenser holder (2) from below, with the condenser iris diaphragm lever, pointing in the microscope front, and tighten the clamping screw (1). (Fig. 8)

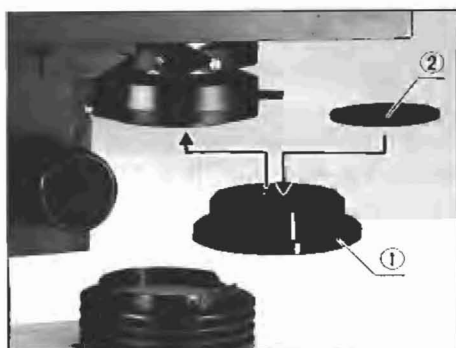

Fig. 9

7 Insertion of the blue filter

Slip the blue filter (32.5 mm dia.) (2) into the filter holder (1) (or into the filter mount at the top of the attachment lens). (Fig. 9)

8 Insertion of the filter holder

Insert the filter holder (1) into the condenser from below. (Fig. 9)



Fig. 10

9 Mounting the field iris diaphragm attachment (optionally available)

- 1) Aligning the positioning clips of the iris diaphragm frame to the cut-outs in the filter mount (1) on the base, insert the iris diaphragm until it clicks in position. (Fig. 10)
- 2) Place the blue filter on the attachment lens and insert the attachment lens into the condenser from below, with the letters "OLYMPUS" facing in the microscope front.

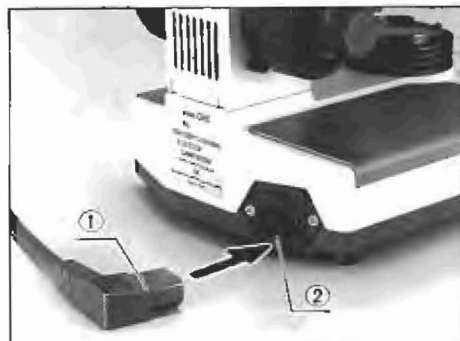

Fig. 11

10 Connecting the power cord

- 1) Plug the power cord (1) into the receptacle (2) on the microscope base. (Fig. 11)

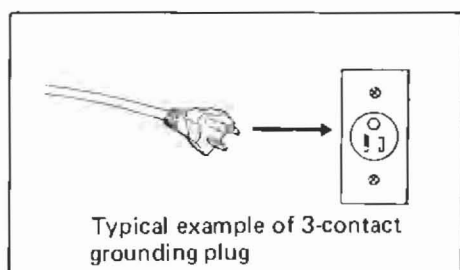

Fig. 12

- 2) Connect the primary cord with a 3-contact plug (it will fit into a ground type power outlet, and no need to connect it to any other grounding device) to an AC outlet.

★ If a 2-contact grounding plug is used, ground the microscope to a properly grounded device (except a gas pipe). If necessary, use an extension cord.

★ This microscope incorporates a noise filter in the electric circuit built-in the microscope stand, bleeding a very low voltage current in order to reduce effect of any external noises. Therefore, if the conductive part of the stand is touched without grounding, an electric shock may sometimes be felt depending upon the humidity conditions of the hands and foot wears.

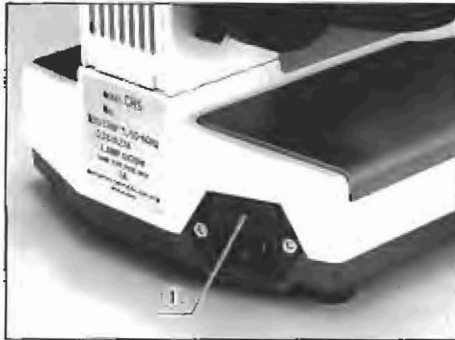

Fig. 13

- Fuse replacement

- 1) The fuse box (1) is located at the back of the microscope base. (Fig. 13)
 - 2) Disconnect the power cord from the AC outlet, and remove the fuse box (1) from the base by means of a screw driver. (Fig. 13)
 - ★ Apply the tip of the screw driver at the lower edge of the fuse box to remove it.
 - ★ The fuse box can accommodate a spare fuse in it.
- Use a fuse as designated by the manufacturer:

Microscope	Fuse amperage
CHS	100V 1A
	200V 0.63A
CHT	100V 0.8A
	200V 0.63A

5 OBSERVATION (Putting the Microscope in Operation)

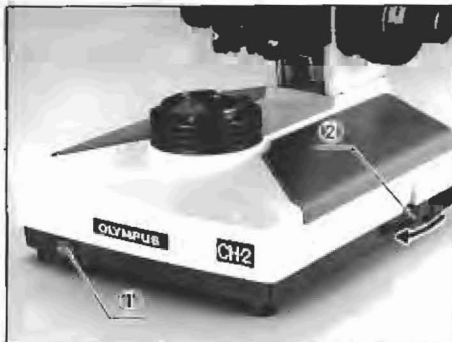

Fig. 14

1 Switching on the bulb

- 1) Turn the power switch (1) ON and adjust the voltage control dial (2) until proper intensity is obtained. (Fig. 14)
- 2) Rotate the dial (2) toward the operator (clockwise) to darken intensity (in the direction of the arrow), or reverse the dial (counterclockwise) to brighten.



Fig. 15

2 Specimen placement

- 1) Open the spring-loaded finger (1) of the specimen holder with one hand, and insert the specimen slide with the cover glass above the specimen into the holder with the other hand. (Fig. 15)
 - ★ Be careful to release the finger (1) gently after the specimen is placed inside the holder.
 - ★ A sudden release of the finger may cause damage to the slide. If fragments of the specimen slide fall on the sliding surfaces of the stage or condenser, malfunctions may result.
- 2) For use of the stage clips in place of the specimen holder, attach a pair of stage clips on the stage, and insert the specimen slide between the stage surface and the clips near the clip stems; then move the slide toward the stage center.

- Cover glass

Use cover glasses of 0.17 mm thickness in conjunction with the objectives marked with the inscription "160/0.17" for optimum performance of these objectives.

- Specimen slide

Specimen slides between 0.9 mm and 1.2 mm in thickness are recommended for the CHS/CHT microscopes. If the thickness of a slide exceeds this range, illumination may sometimes be impaired.



Fig. 16

3 Focus

- 1) Swing in the 10X objective.
- 2) Bring the specimen into focus by means of the coarse and fine adjustment knobs.
 - ★ Rotate the focus adjustment knobs clockwise (in the direction of the arrow in Fig. 16), and you can raise the stage (or the specimen approaches the objective).

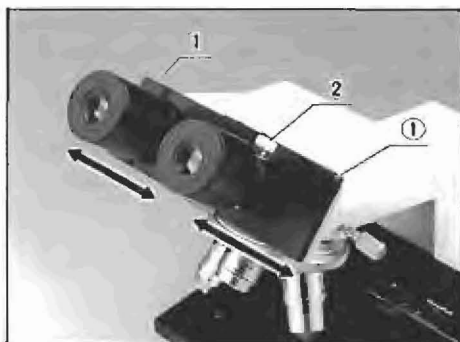

Fig. 17

4 Interpupillary distance adjustment

- 1) Looking through the binocular tube, move the knurled dovetail slides (1) in the directions of the arrows until a perfect binocular vision is obtained. (Fig. 17)
- 2) If you memorize your interpupillary distance setting on the scale (2) provided between the dovetail slides (1), it is convenient to obtain a proper setting next time. (Fig. 17)

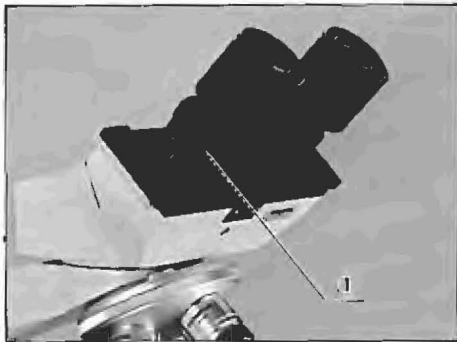

Fig. 18

5 Diopter adjustment

- 1) Look at the image through the right eyepiece with your right eye, and focus on the specimen with the focus adjustment knobs.
- 2) Next, looking at the image through the left eyepiece with your left eye, rotate the diopter adjustment ring (1) to focus on the specimen without using the focus adjustment knobs. (Fig. 18)

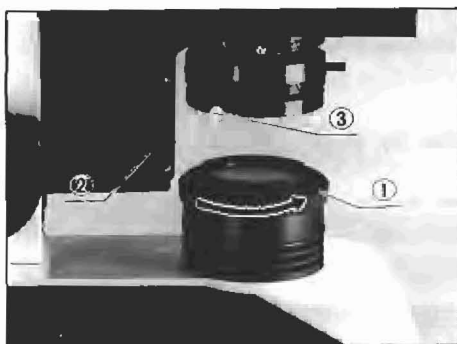

Fig. 19

6 Centration of the field iris diaphragm CH2-FS (optional)

- 1) Rotate the diaphragm ring (1) counterclockwise to stop down the iris diaphragm to the minimum. (Fig. 19)
- 2) Rotate the condenser height adjustment knob (2) in either direction until the image of the field diaphragm is visible sharply in the field of view. (Fig. 19)
- 3) Bring the image of the field diaphragm into the center of the field by means of the two attachment lens centering screws (3). (Figs. 19, 20)

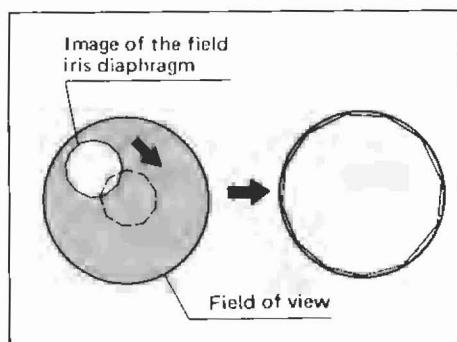

Fig. 20

- 4) Open the diaphragm until the small ring of the diaphragm inscribes the field of view. If the polygonal ring is not concentric with the field of view, repeat the centering procedure mentioned above. (Fig. 20)
- 5) After centration is complete, re-open the diaphragm until it becomes a larger polygonal ring around (or circumscribes) the circular edge of the field.



Fig. 21

7 Objective change

- 1) Swing in the objective to use. (Fig. 21)
- 2) Be certain to click the nosepiece in position.

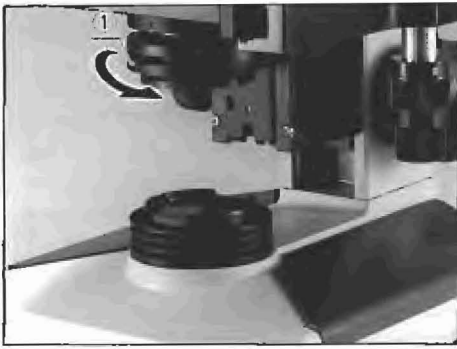

Fig. 22

8 Adjustment of the aperture iris diaphragm

The opening of the aperture iris diaphragm built in the condenser can be adjusted to match with the numerical aperture of the objective in use, in order to achieve optimum objective performance as depth of focus, image contrast and resolution.

- 1) Turning the diaphragm lever ① counterclockwise reduces the diaphragm opening. (Fig. 22)

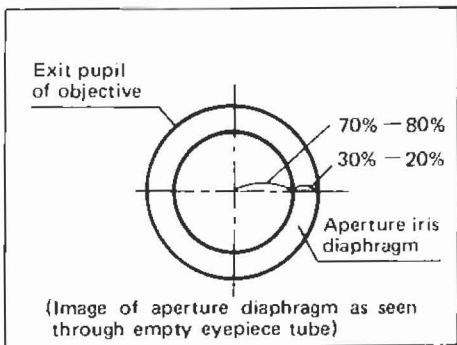

Fig. 23

- 2) Remove the eyepiece, and looking at the exit pupil of the objective through the empty eyepiece tube, adjust the opening of the diaphragm. Generally, it is preferable to stop down the aperture diaphragm to 70% to 80% of the objective N.A. (Fig. 23)

If the specimen is lightly stained, or almost colorless and transparent, further reduce the diaphragm opening to increase contrast for better image observation. Be careful, however, if the diaphragm is stopped down too much, the resolution will be deteriorated.

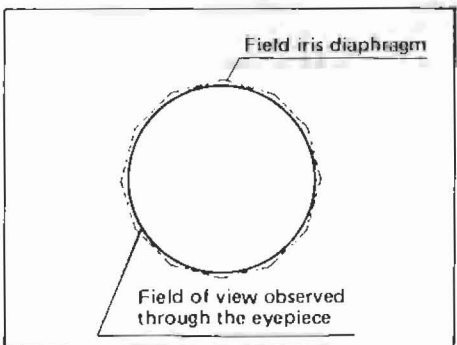

Fig. 24

9 Adjustment of the field iris diaphragm (for CH2-FS only)

- 1) The field iris diaphragm controls the diameter of the ray bundle impinging on the specimen and therefore, by stopping down the field diaphragm until it is slightly larger than the field of view, it can reduce stray light, which in turn increases image definition and contrast. (Fig. 24)
- 2) Turning the field diaphragm ring ① (Fig. 19) counterclockwise reduces the diaphragm opening, or reverse the ring to increase the opening.

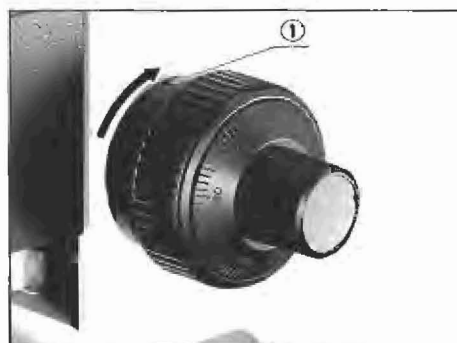

Fig. 25

10 Tension adjustment of the coarse adjustment knobs

- 1) A tension adjustment ring ① is provided next to the coarse adjustment knob. With this device the tension of the coarse adjustment is freely adjustable for either heavy or light movement, depending upon operator preference. (Fig. 25)

Applying the tip of a large screwdriver at a groove in the periphery of the tension adjustment ring ①, rotate the ring in the direction of the arrow to increase the tension, or reverse the ring to loosen.

- 2) However, do not loosen the tension adjustment ring too much, because this may cause the stage to drop or the fine adjustment knobs to slip.

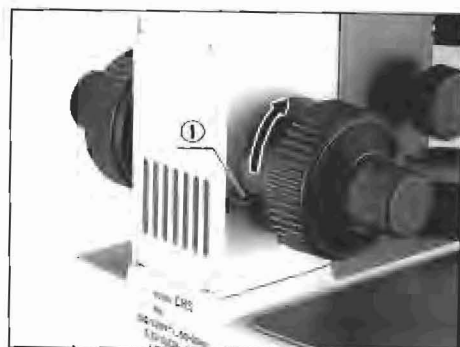

Fig. 26

11 Locking of the pre-focusing lever

This lever ① is provided to prevent possible contact between specimen and objective as well as to simplify coarse focusing. The lever is locked in the direction of the arrow in Fig. 26, after coarse focus has been accomplished. This is convenient for liquid application or change of specimens, too, since it prevents further upward travel of the stage by means of the coarse adjustment knobs, and provides a limiting stop if the stage is lowered and then raised again. The pre-focusing lever does not restrict fine focusing.

★ Unlock this lever when not in use.

12 Use of immersion objectives

- 1) To utilize the full numerical aperture of an immersion objective (with inscription "oil"), the objective and specimen are immersed in an immersion oil in a following procedure:
- 2) Focus on the specimen with a low power objective.
- 3) Put a drop of immersion oil on the specimen slide and the front lens of the immersion objective.
- 4) Turn the nosepiece to bring the immersion objective into the light path, and focus with the fine adjustment knobs.
 - ★ Use of the pre-focusing lever facilitates steps 2) through 4) above.
 - ★ Care should be taken to prevent oil bubbles from forming in the oil film; if any, re-apply immersion oil, since these bubbles greatly deteriorate the lens performance.
 - ★ Be careful not to stain other objectives with immersion oil, and after use, carefully wipe off the immersion oil on the objective, etc. completely.

6 PHOTOMICROGRAPHY

A trinocular tube BH-TR45-W, optionally available, is used for photomicrography with the CHS/CHT microscope in conjunction with Olympus photomicrographic equipment PM-10AK (automatic), PM-10M (manual), photomicrographic camera BH2-PM-6-8, OM camera backs, etc. Read the instruction manual of each equipment in use for explanation in detail.

6-1 System Diagram of Olympus Photomicrographic Equipment (optionally available)

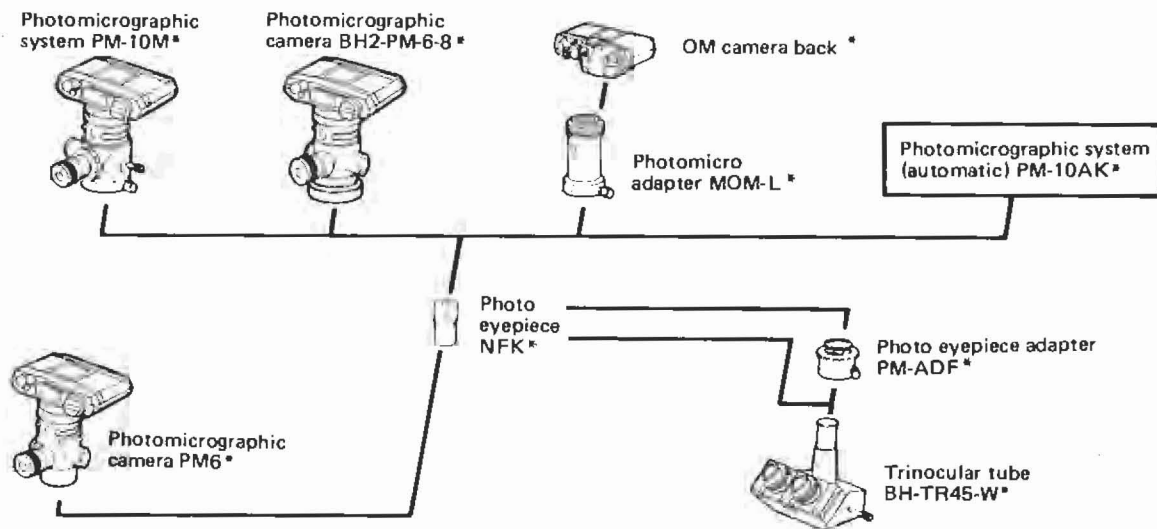

*Optional accessories

6-2 Setup of the Photomicrographic Equipment

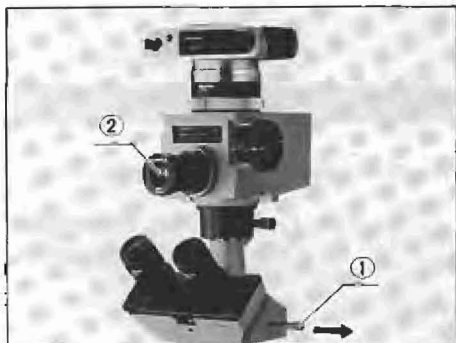

Fig. 27

1 Mounting the PM-10AK, PM-10M or PM-6-8 on the microscope

- 1) Each of these attachments can be mounted on the photo tube of the trinocular tube as photographed in Fig. 27. (Fig. 27 shows the PM-10AK on the trinocular tube.)
- 2) Use the photo eyepiece NFK3.3X or NFK5X.
- 3) Pull out the light path selector lever (1) to deflect the light to the photo tube. (Fig. 27)
- 4) Looking through the focusing telescope (2), focus on the specimen. (Fig. 27)

★ In case of long time exposure, ambient light in the room will go through the eyepieces, and its image formed on the film plane may cause ghost or flare; to exclude this extraneous light, dim the room or cap the eyepieces during photographic procedure.

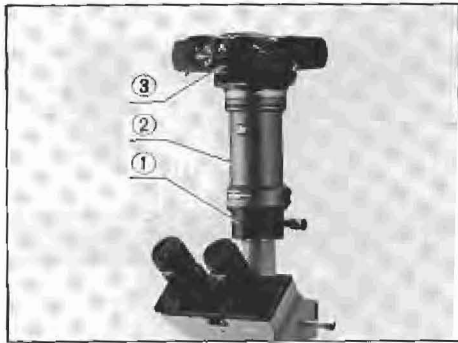

Fig. 28

2 Mounting the OM camera back

- 1) Mount the photo eyepiece adapter PM-ADF ① (into which a choice of NFK photo eyepiece is inserted), Photomicro adapter (MOM-L) ② and OM camera back ③ on the photo tube in this order. (Fig. 28)
- 2) The compatible photo eyepieces are NFK3.3X and NFK5X.
- 3) Bring the specimen into focus, looking through the viewfinder of the camera.
- 4) Photomicrographic magnification equals the objective magnification multiplied by the photo eyepiece magnification.

★ To take a good photomicrograph with a single lens reflex camera back, a shutter speed at 1/2 second or slower is recommended so as to reduce the mirror-lockup shock.

6-3 Color Temperature Regulation (for use of daylight color film)

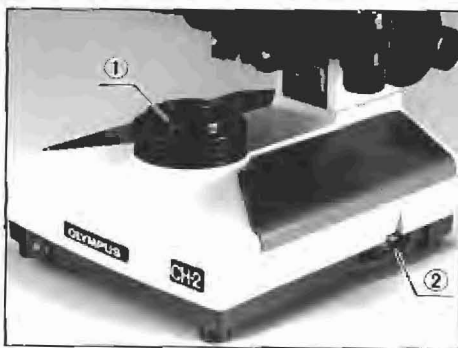

Fig. 29

1 Use of the light balancing filter 45LBD-2N (optionally available)

- 1) Remove the blue filter from the condenser.
- 2) Slip a 45LBD-2N filter into the filter mount ① at the light exit on the microscope base. (Fig. 29)
- 3) Turn the voltage control dial ② until the dial is aligned at the graduation "10" (maximum), and daylight color can be obtained. (For CHS only).

★ The 45LBD-2N filter cannot be used with the CHT microscope for color temperature regulation.

The optionally available color balancing filter 45LBD-2N is specially designed to obtain a better color rendition for daylight type color film than a blue filter.

2 Use of the blue filter 32.5C-2

- 1) Engage the blue filter as used for observation in the condenser.
- 2) To obtain color temperature for daylight type film, set the voltage control dial ② at the graduation "9" for CHS, or at the graduation "10" for CHT.

★ If a photograph tends to overexposure, do not change the voltage control dial, but apply an optional N.D. filter (45mm dia.) to the filter mount at the light exit on the microscope base.

★ Since the blue filter tends to characteristically leave somewhat a yellowish tint, an optionally available 45LBD-2N is recommended for better improvement of color rendition in conjunction with the CHS microscope. However, the CHT microscope can be used only with the blue filter for color temperature compensation.

■ D Achromat

Objective	Type	D Achromat			
	Magnification	4X	10X	40X	100X*
N.A.	0.10	0.25	0.65	1.30	
W.D. (mm)	18.23	7.18	0.63	0.20	
Focal length (mm)	30.03	16.90	4.58	1.66	
Resolving power (μ)**	3.4	1.3	0.52	0.26	
Eyepiece	Remarks			Spring-loaded	
CWHK10X (Field number 18)	Total magnification	40X	100X	400X	1000X
	Focal depth (μ)	172.5	27.60	3.03	0.66
	Field of view (mm)	4.5	1.8	0.45	0.18

■ E D Achromat

Objective	Type	E D Achromat			
	Magnification	4X	10X	40X	100X*
N.A.	0.10	0.25	0.65	1.25	
W.D. (mm)	29.00	6.30	0.53	0.20	
Focal length (mm)	31.05	16.45	4.59	1.90	
Resolving power (μ)**	3.4	1.3	0.52	0.26	
Eyepiece	Remarks			Spring-loaded	
CWHK10X (Field number 18)	Total magnification	40X	100X	400X	1000X
	Focal depth (μ)	172.5	27.60	3.03	0.67
	Field of view (mm)	4.5	1.8	0.45	0.18

*Immersion objectives

**The resolving power is obtained with the fully opened aperture diaphragm.

Glossary:

- Working distance: The distance from the specimen or cover glass to the nearest point of the objective.
- Numerical aperture: The N.A. represents a performance number which could be compared to the relative aperture (f-number) of a camera lens. The quantity of light which the objective receives from the object increases with the square of the performance number.
- Resolving power: The resolving power of a lens is measured by its ability to separate two points.
- Focal depth: The distance between the upper and lower limits of sharpness in the image formed by an optical system. As you stop down the aperture iris diaphragm, the focal depth becomes deeper. The larger the N.A. of the objective the shallower the focal depth.
- Field number: A number that represents the diameter in mm of the image of the field diaphragm that is formed by lens in front of it.
- Field-of-view diameter: The actual size of the field of view in mm.
- Total magnification: Equals the objective magnification multiplied by the eyepiece magnification.



TROUBLESHOOTING GUIDE

If you are unable to obtain full performance from your microscope because of your unfamiliarity, please consult with the table below as pointers for troubleshooting:

Trouble	Cause	Remedy
1. Optical system		
a) Field of view is cut off, or illuminated irregularly.	Nosepiece is not clicked into place.	Slightly rotate the nosepiece until it clicks into position. (p. 11)
	Condenser is not correctly mounted on the condenser holder.	Re-insert the condenser all the way without tilt. (p. 7)
	Field iris diaphragm is not centered.	Center it correctly. (p. 11)
	Field iris diaphragm is stopped down too much.	Open it properly. (p. 12)
	Dust or dirt on objective, eyepiece, condenser or light exit glass on microscope base	Clean each lens or glass.
b) Dust or dirt is visible in the field of view.	Dust on the light exit glass on the microscope base	Remove dust or dirt, or clean the specimen.
	Dust on the condenser top lens	
	Dirty specimen	
	Dust on eyepiece	
c) Excessive image contrast	Condenser is lowered too much.	Raise the condenser. (p. 7)
	Aperture iris diaphragm is stopped down excessively.	Open the diaphragm. (p. 12)
d) Resolution problems: <ul style="list-style-type: none"> • Image is not sharp. • Insufficient contrast • Image details lack definition. 	Objective is not correctly engaged in the light path.	Slightly rotate the nosepiece until it clicks into position. (p. 11)
	Dirt on the objective front lens	Clean the objective.
	Immersion objective is used without immersion oil.	Apply immersion oil. (p. 13)
	Bubbles in the immersion oil	Remove bubbles. (p. 13)
	Olympus immersion oil is not used.	Use Olympus immersion oil.
	Dirty specimen	Clean the specimen, eyepiece or condenser lens.
	Dust on eyepiece or condenser top lens	
e) Field of view is partially out of focus.	Objective is not correctly positioned in the light path.	Slightly rotate the nosepiece until it clicks into position. (p. 11)
	Specimen is not correctly placed on the stage.	Replace it on the stage correctly and secure it with the specimen holder or stage clips. (p. 9)
f) Image is tinted yellowish.	Blue filter is not engaged.	Engage blue filter. (p. 8)





Trouble	Cause	Remedy
2. Focus adjustment mechanism		
a) Coarse adjustment knobs are too tight.	Tension adjustment ring is tightened too much.	Loosen the tension adjustment ring slightly. (p. 12)
	User is trying to raise the stage, passing over the upper focusing limit imposed by the engaged pre-focusing lever.	Unlock the pre-focusing lever. (p. 13)
b) Stage drops and the specimen goes out of focus.	Tension adjustment ring is too loose.	Tighten the ring properly. (p. 12)
c) Stage cannot be raised to the upper limit.	Pre-focusing lever is engaged in lower than focusing position.	Unlock the lever. (p. 13)
d) Stage cannot be lowered to the lower limit of the working range.	Substage is lowered too much.	Raise the substage.
e) Objective front lens touches the specimen.	Specimen is mounted on the stage upside down.	Reverse the specimen. (p. 9)
3. Binocular tube		
Incomplete binocular vision	Interpupillary distance is not correctly adjusted.	Correct the interpupillary distance. (p. 10)
	Diopter adjustment is incomplete.	Complete the diopter adjustment. (p. 11)
	Right and left eyepieces are not matched.	Use a pair of matched eyepieces.
	User is unaccustomed to binocular vision.	Prior to looking at the image of the specimen, try to look at the entire field of view, or look at a far away object before resuming microscopic observation.
4. Stage		
a) Image easily goes out of focus when you touch the stage.	Stage clamping knobs are not tightened.	Tighten clamping knobs with a coin securely. (p. 7)
b) Image blurs as you move the specimen.	Specimen is not correctly positioned on the stage.	Adjust specimen position. (p. 9)
5. Objective change		
Front lens of high power objective comes into contact with specimen when it is engaged after low power objective.	Specimen is mounted on the stage upside down.	Reverse the specimen. (p. 9)
	Cover glass is too thick.	Use a 0.17mm-thick cover glass. (p. 10)



Trouble	Cause	Remedy
2. Focus adjustment mechanism		
a) Coarse adjustment knobs are too tight.	Tension adjustment ring is tightened too much.	Loosen the tension adjustment ring slightly. (p. 12)
	User is trying to raise the stage, passing over the upper focusing limit imposed by the engaged pre-focusing lever.	Unlock the pre-focusing lever. (p. 13)
b) Stage drops and the specimen goes out of focus.	Tension adjustment ring is too loose.	Tighten the ring properly. (p. 12)
c) Stage cannot be raised to the upper limit.	Pre-focusing lever is engaged in lower than focusing position.	Unlock the lever. (p. 13)
d) Stage cannot be lowered to the lower limit of the working range.	Substage is lowered too much.	Raise the substage.
e) Objective front lens touches the specimen.	Specimen is mounted on the stage upside down.	Reverse the specimen. (p. 9)
3. Binocular tube		
Incomplete binocular vision	Interpupillary distance is not correctly adjusted.	Correct the interpupillary distance. (p. 10)
	Diopter adjustment is incomplete.	Complete the diopter adjustment. (p. 11)
	Right and left eyepieces are not matched.	Use a pair of matched eyepieces.
	User is unaccustomed to binocular vision.	Prior to looking at the image of the specimen, try to look at the entire field of view, or look at a far away object before resuming microscopic observation.
4. Stage		
a) Image easily goes out of focus when you touch the stage.	Stage clamping knobs are not tightened.	Tighten clamping knobs with a coin securely. (p. 7)
b) Image blurs as you move the specimen.	Specimen is not correctly positioned on the stage.	Adjust specimen position. (p. 9)
5. Objective change		
Front lens of high power objective comes into contact with specimen when it is engaged after low power objective.	Specimen is mounted on the stage upside down.	Reverse the specimen. (p. 9)
	Cover glass is too thick.	Use a 0.17mm-thick cover glass. (p. 10)

Trouble	Cause	Remedy
6. Electric system		
a) Illuminator is too bright with the voltage control dial even at the lowest position (closest to the operator).	Voltage selector switch is not matched with the line voltage.	Conform the switch to the line voltage. (p. 6)
	Line voltage is too high.	Adjust the line voltage with a variable voltage transformer.
	Bulb is not a standard one.	Use a standard bulb. (p. 6)
b) Output voltage for the illuminator cannot be controlled (too high or too low).	Voltage selector switch is not matched with the line voltage.	Conform the switch to the line voltage. (p. 6)
	Line voltage is too high (or too low).	Adjust the line voltage with a variable voltage transformer.
c) Light flickers and intensity is unstable.	Line voltage is unstable.	Use a voltage stabilizer.
	Filament of the bulb is likely to burn out.	Replace the defective bulb. (p. 6)
	Loose electric cords	Secure the connections. (p. 8)
d) Fuse burns out too often.	Fuse is not a standard one.	Use a standard fuse. (p. 9)
	Voltage selector switch is not matched with the line voltage.	Conform the switch to the line voltage. (p. 6)
e) Bulb does not light.	Fuse is gone.	Replace the fuse. (p. 9)
	Bulb is burned out.	Replace the bulb. (p. 6)
	Loose electric connections.	Secure the connections. (p. 8)
f) Reduced bulb life	Voltage selector switch is not matched with the line voltage.	Conform the selector switch to the line voltage. (p. 6)
	Bulb is not a standard one.	Use a standard bulb. (p. 6)
	Bulb was overvolted too long.	Reduce bulb voltage. (p. 9)

OLYMPUS

OLYMPUS OPTICAL CO., LTD.

43-2, Hatagaya 2-chome, Shibuya-ku, Tokyo, Japan

OLYMPUS OPTICAL CO., (EUROPA) GMBH.

(Premises/Goods delivery) Wendenstrasse 14-16, 20097 Hamburg, Germany
(Letters) Postfach 10 49 08, 20034 Hamburg, Germany

OLYMPUS AMERICA INC.

2 Corporate Center Drive, Melville, N.Y. 11747-3157, USA

OLYMPUS OPTICAL CO. (U.K.) LTD.

2-8 Honduras Street, London EC1Y0TX, United Kingdom

