



User's Manual
[Hardware Manual]

FLUOVIEW
FV1000
CONFOCAL LASER SCANNING
BIOLOGICAL MICROSCOPE

FV10-ASW [Ver.3.1]

Notice

Thank you for your purchase of Olympus microscope at this time.
Retain this manual in an easily accessible place near a system for future reference.

AX8061

CAUTION

FV1000 is a CLASS 3B laser product.

The procedures for using this system are classified as follows:

- Service

“Service” means any adjustment or repair performed by highly trained and skilled technical personnels who are provided the service training following to the service manual for this system.

The performance has influence on the feature of this system, and there is a risk which unintended CLASS 3B laser light is emitted.

- Maintenance

“Maintenance” means adjustment or other procedures performed by customers to maintain that this system functions properly.

- Operation

“Operation” means all performance described in the user’s manuals in this system.

CLASS 3B laser light is only emitted from the objective lens during the actual execution.

The User’s Manuals of this system consist of the following:

In order to maintain the full performance of this system and ensure your safety, be sure to read these user’s manuals and the operating instructions for the laser unit and light source unit before use.

- FV1000MPE / FV1000 User’s Manual [Laser Safety Guide]
- FV1000 User’s Manual [Safety Guide]
- FV1000 User’s Manual [Hardware Manual]
- FV1000 FV10-ASW User’s Manual [Quick Start]

Also, we have prepared one service manual for this system as below. Technical personnels who perform the service require to take the service training.

- FV1000MPE / FV1000 Service Manual

Reproduction, copying or duplication of a part or all of this software and manual is prohibited.

Registered Trademarks



Registered Trademarks

Microsoft, Microsoft Windows, Excel for Windows are registered trademarks of Microsoft Corporation.
Other brand names and product names are trademarks or registered trademarks of their respective owners.

MANUAL CONFIGURATION

I. SYSTEM OVERVIEW

1. System Overview.....I.	1-1
---------------------------	-----

II. PREPARATION For OPERATION

1. Preparation for Operation.....II.	1-1
2. Replacement of Cubes.....II.	2-1
3. Centration of Mercury Burner.....II.	3-1
4. Replacement of Lamps.....II.	4-1





III. TROUBLE Q&A

1. Troubleshooting Guide.....III.	1-1
-----------------------------------	-----

NOTATIONS IN THIS MANUAL

This manual complies with the following notations.

✧ Notation of Caution, Notes and Tips

Notation	Description
	It indicates caution to prevent physical damage to user or damage to product (including furniture in peripheral area).
	Indicates details of caution to prevent damage or deterioration of products.
	Hint or one point advice appears with  attached.



I. SYSTEM OVERVIEW

On This Volume

This volume describes the overview of the FLUOVIEW FV1000 system.
Please read this volume so that you can understand the system before use.

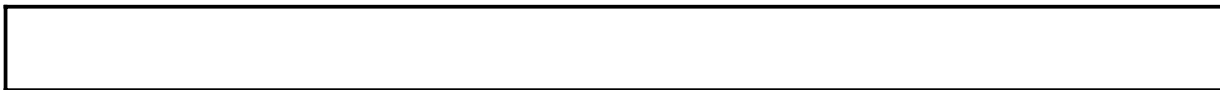

1 System Overview **1-1**

1-1 Principles.....	1-1
1-2 Features of the FV1000	1-2
1-3 Optical Path Diagram	1-3
1-4 System Configuration	1-4
1-4-1 System Diagram.....	1-4
1-4-2 System Appearance and Functions.....	1-5

1 System Overview

OLYMPUS FV1000 is a confocal laser scanning biological microscope system featuring improved basic performances (sensor system, scanning system and illumination system performances) by considering the “live cell observations”, with which long hours of stable measurement of weak fluorescence is required.

This microscope is equipped with 3 fluorescence channels, 3 lasers and AOTF to meet various applications in a wide range of advanced research fields.

1-1 Principles

A laser scanning microscope converges the laser beam into a small spot using an objective and scans the specimen in the X-Y direction using the laser beam.

The microscope then captures the fluorescent light and reflected light from the specimen using light detectors and outputs the specimen image on an image monitor.

As shown in this figure, the confocal optics incorporates a confocal aperture on the optically conjugate position (confocal plane) with the focus position to eliminate light from other part than the focus position. This causes the extraneous light to be viewed as darkness in the observation image, it is possible to slice optically a tissue specimen that has thickness.

On the other hand, an ordinary optical microscope, the light from other part than the focus position is overlapped with the imaging light of the focus position so the image is blurred in overall.

The laser beam that has transmitted through the specimen is detected by the transmitted light detector and provides the transmitted image, which is not a confocal image.

However, when the fluorescence images of the transmitted and confocal images are combined, it is possible to obtain very important information on the specimen.

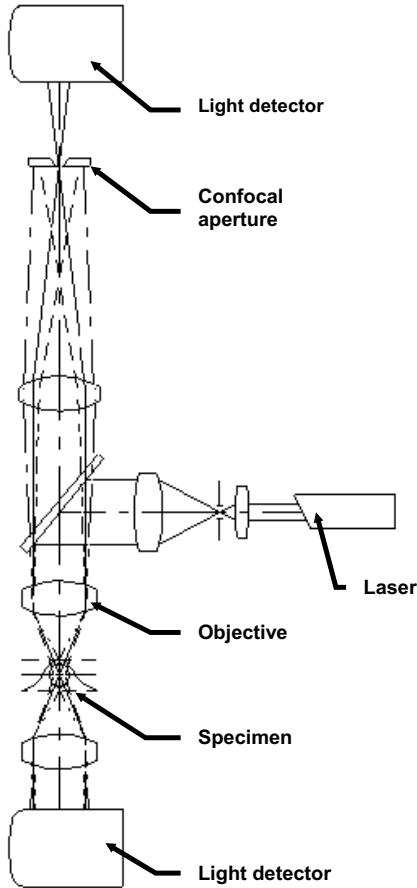

1-2 Features of the FV1000

1. The photon counting mode is newly provided to improve the sensitivity and S/N and to enable quantitative optical intensity measurement. Photon counting makes possible long hours of quantitative observation by completely eliminating analog-derived drift. The dynamic range in which photon counting is possible is expanded using a newly designed wideband head amplifier and processing circuitry.
2. High-speed imaging at 8 frames per sec. is made possible by fast galvano mirror. In addition, high-speed image acquisition is possible without stopping the Z-series motors used in the XYZ and XZ observations.
3. During long hours of time-lapse observation, a stable supply of excitation light is made possible thanks to the feedback control of the intensity of each laser. Together with the photon counting function, this function ensures the stability and quantitative nature of long-hour observations.
4. Three fluorescence channels, three lasers and AOTF are provided as standard to meet a large variety of applications.
5. With a fully-motorized scan unit and motorized microscope, the entire system is motorized so the scanning conditions including those of the optics can be saved and reproduced.
6. When an extension laser irradiation unit is used for photon activation aiming at causing discoloration, optical simulation or uncaging of the specimen, a system optimized for cell function analysis experiments can be built.
7. When the system incorporates the spectral detector unit that is composed of a 2-channel spectral detector and 1-channel filter, it is possible to set the detection conditions more flexibly, acquire the fluorescence spectral data and use the fluorescence isolation function.

1-3 Optical Path Diagram

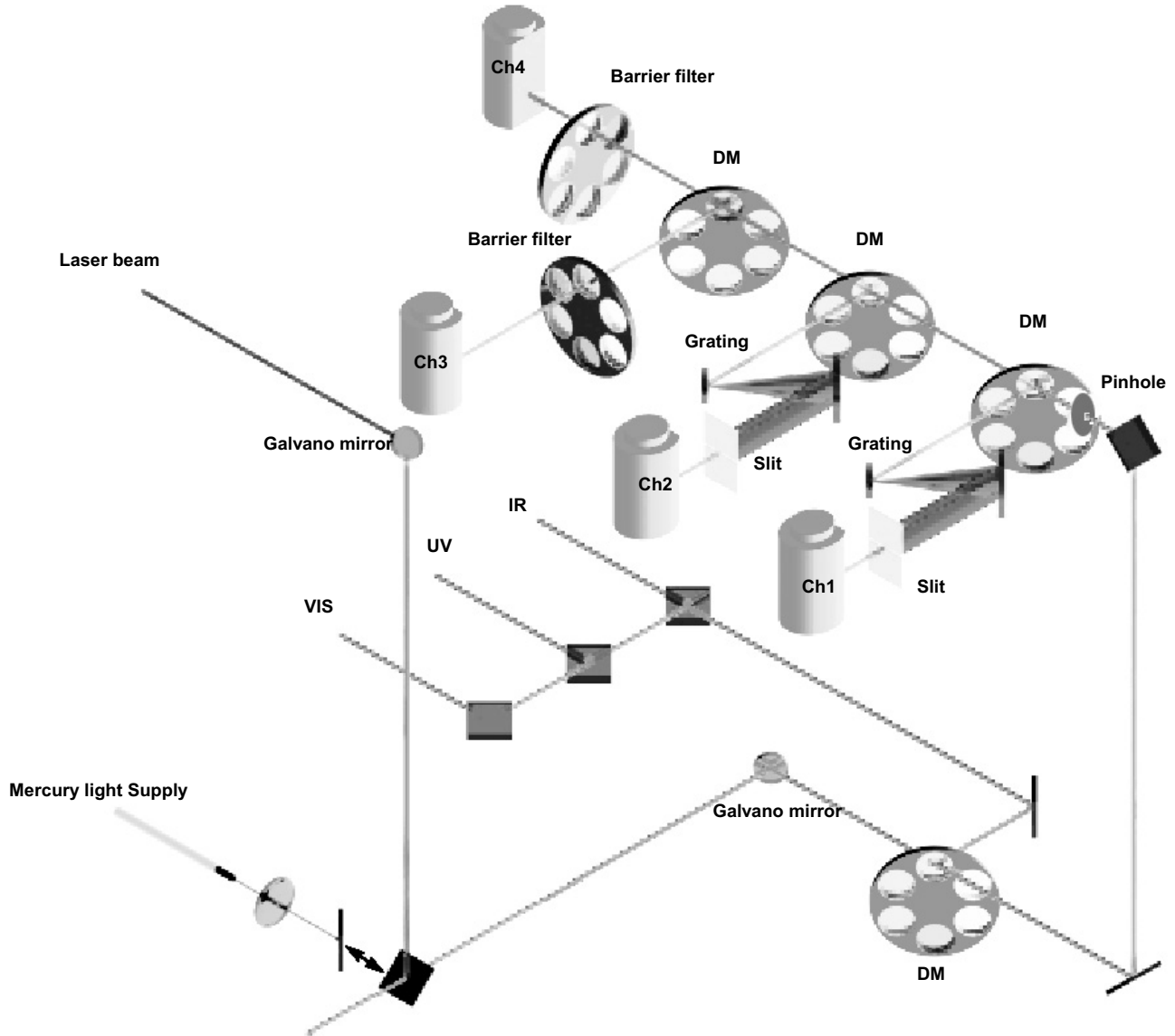

1-4 System Configuration

1-4-1 System Diagram

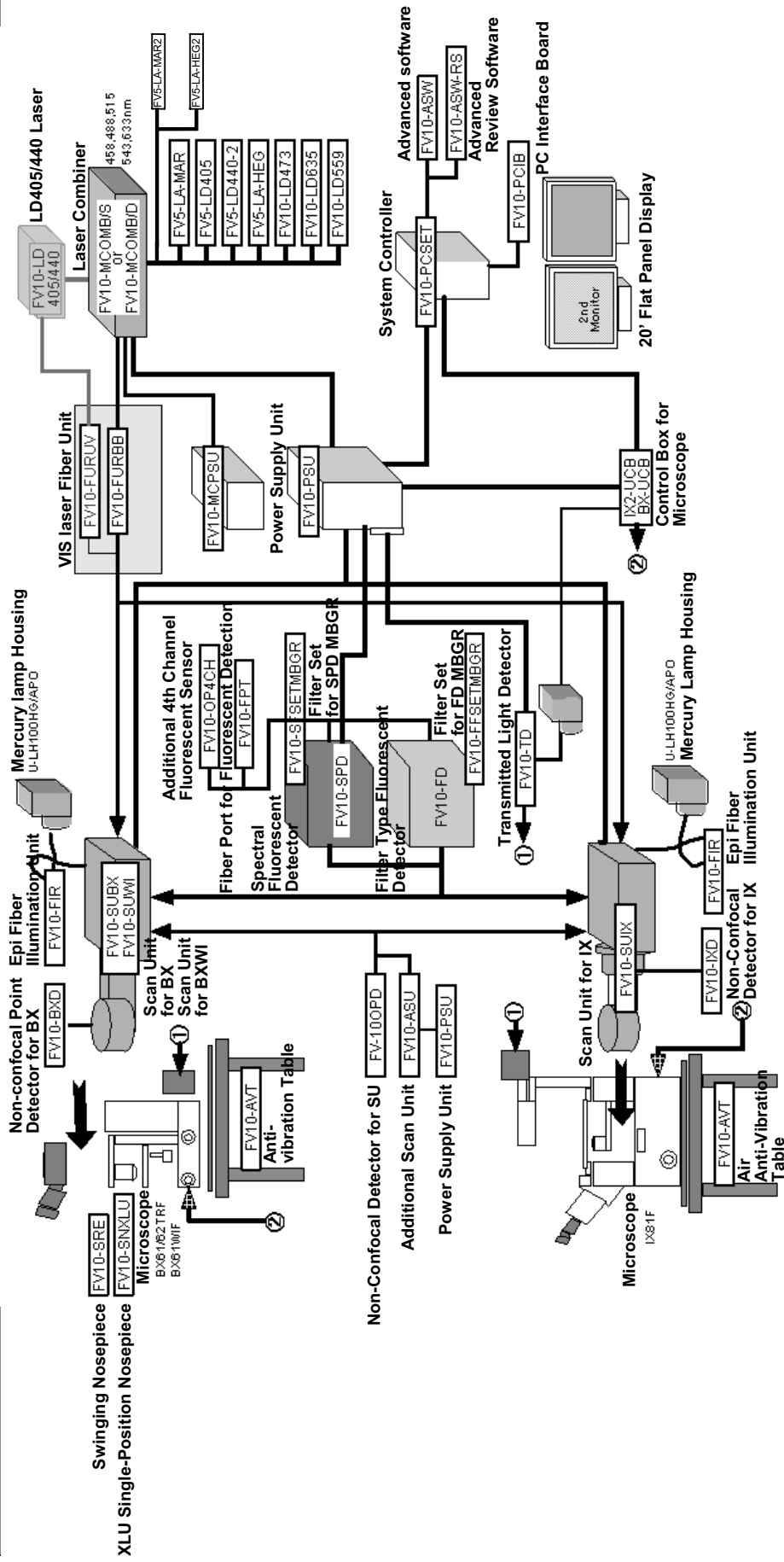

1-4-2 System Appearance and Functions

The applicable microscopes are the BX61/62TRF, BX61WIF and IX81F.

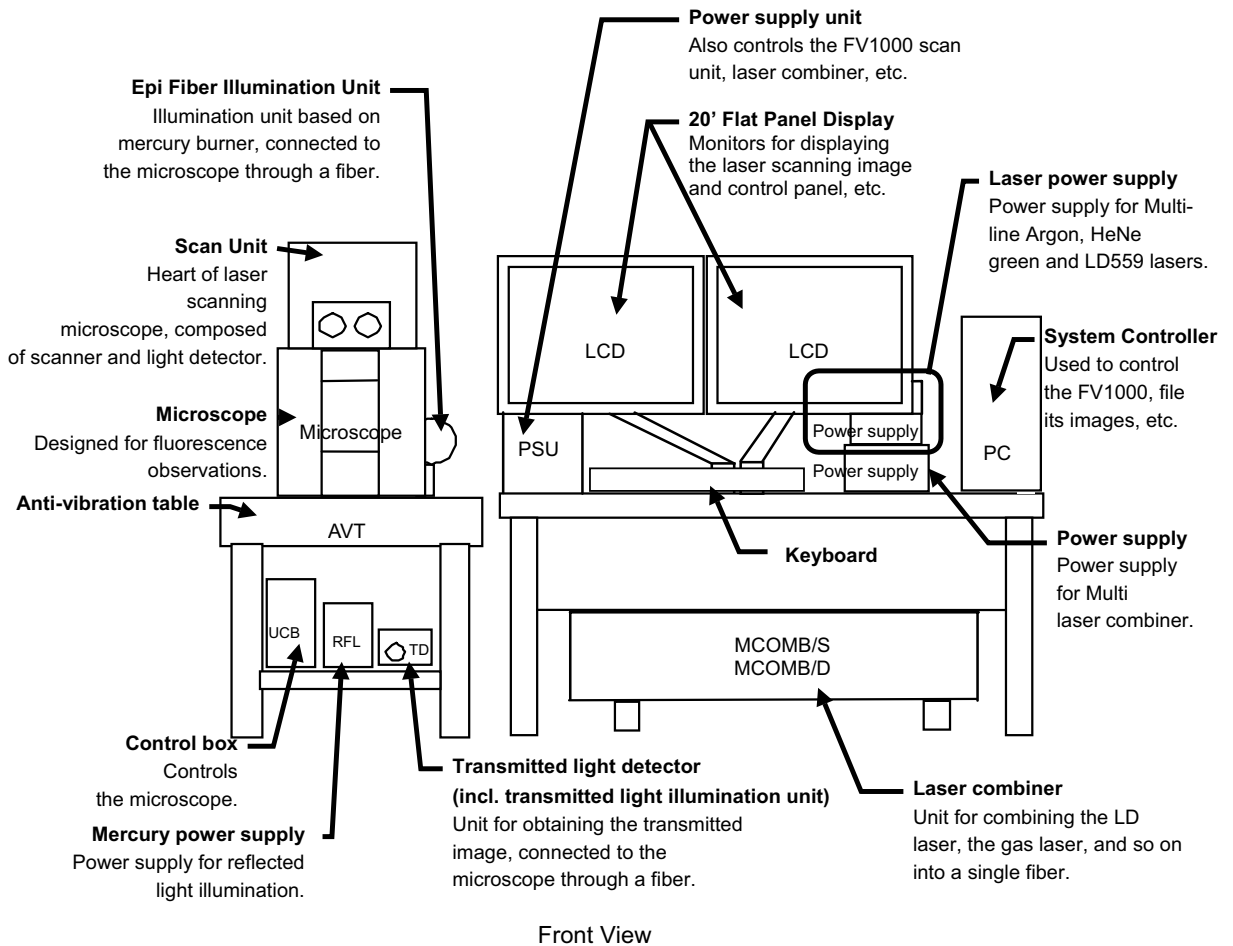
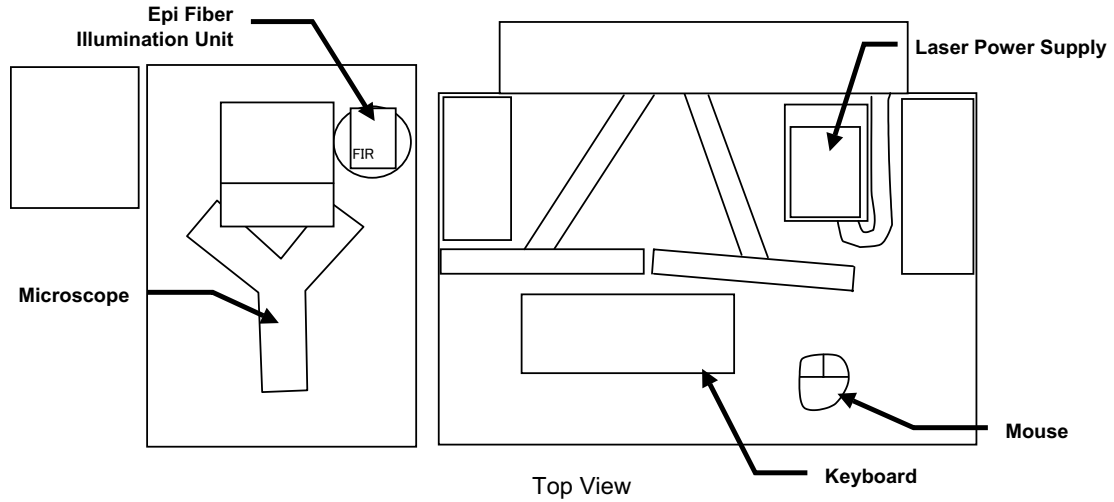

II. PREPARATION For OPERATION

On This Volume

This volume describes the methods for preparation for operation of the FLUOVIEW FV1000 system. After completing the preparations, activate the software and start observation by controlling the display on the monitor screen.
Please read this volume so that you can understand the system before use.

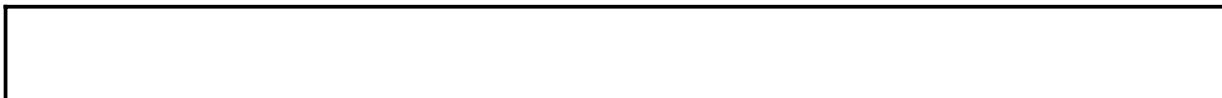

1 Preparation for Operation **1-1**

1-1 Turning the Power On	1-1
1-2 Starting the Software	1-4
1-3 Exiting from the Software	1-5
1-4 Turning the Power Off	1-5

2 Replacement of Cubes **2-1**

2-1 Replacing the DM Cube	2-1
2-1-1 With the FV10-ASU	2-1
2-1-2 With the FV10-OPD	2-3
2-2 Replacing the Spectral Cube	2-4
2-2-1 Removing the spectral cube	2-4
2-2-2 Fabricating a spectral cube	2-5
2-2-3 Attaching the spectral cube	2-6

3 Centration of Mercury Burner **3-1**

4 Replacement of Lamps **4-1**

4-1 The Bulb	4-1
4-2 The Mercury Burner.....	4-2

1 Preparation for Operation

1-1 Turning the Power On

FV5-LAMAR-2 power supply



FV5-LAMAR power supply



FV5-LAHEG-2 power supply



FV5-LAHEG power supply



1. Set the power switches of the following units to I (ON).
 - Power Supply Unit FV10-PSU
 - Mercury Burner Power Supply Unit
 - Microscope Control Box BX-UCB or IX2-UCB

2. Set the power switches of the PC and monitor to I (ON).

3. Turn on the lasers as follows.

3.1 Multi-line Argon laser: FV5-LAMAR-2

- Set the power switch to ON. (This starts the fan of the laser.)
- Turn the key to the ON position.

3.2 Multi-line Argon laser: FV5-LAMAR

- Set the power switch to ON. (This starts the fan of the laser.)
- Turn the key to the ON position.

It takes a few tens of seconds after the key is set to ON till the laser oscillation begins.

3.3 Helium-Neon Green Laser: FV5-LAHEG-2 or FV5-LAHEG

- Turn the key to the I (ON) position.

It takes a few tens of seconds after the key is set to ON till the laser oscillation begins.

NOTE

To ensure stable laser light output, it is recommended to warm up the laser power supply after turning it on. The warm-up period should be 10 minutes or more when using the Argon laser power supply and 30 minutes or more when using the Helium-Neon Green or Red laser power supply.

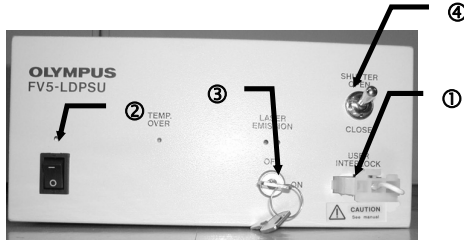

LD405/440 laser power supply

3.4 LD405/440 laser: FV10-LD405/440

- Make sure that the provided shorting plug is attached to the remote interlock ① or that is connected to your equipment and the interlock is released.
- Set the power switch ② to ON.
- Turn the key ③ to the ON position.
- Set the shutter switch ④ OPEN.



The red lighting of the LASER EMISSION LED of the LD405/440 laser power supply indicates that the laser is oscillating. With a certain setup, the laser beam is output by simply setting the shutter switch ④ to ON.

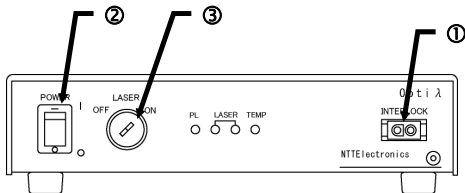

FV10-LD559 laser power supply

3.5 LD559 laser: FV10-LD559

- Verify that the remote interlock ① is set properly.
- Connect the power cord with power receptacle.
- Turn POWER switch ② to | - (ON). TEMP lamp will blink in green and temperature adjustment will take place. When the temperature adjustment is completed, the blinking of TEMP lamp will turn to lighting. Hold on (about 3 minutes) until the adjustment is completed.
- Insert the provided key into LASER key switch ③ and turn it ON. LASER lamp will blink in red and calibration¹ will take place. When the calibration is completed, the blinking of LASER lamp will turn to lighting and a laser beam will be emitted in stable output condition. Hold on (about 2 minutes) until the calibration is completed. (When LASER key is turned ON, first time, after POWER switch is turned ON, the calibration will be executed.)

¹ About calibration

Calibration is performed to adjust the setting temperature of optical element inside the laser head to optimal condition.

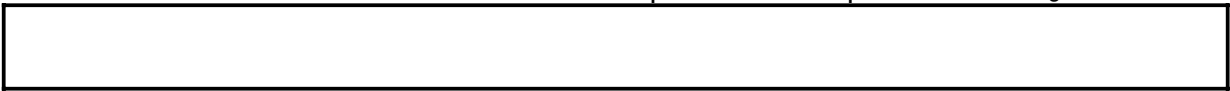

Be careful as a stronger laser beam than the rated power may be emitted during calibration.



Temperature error would occur if LASER key switch is turned OFF during calibration. In such a case, turn POWER switch to OFF and start the system again.



In an event that a power control error (PL lamp lit in orange) occurred while the system is in use, turn both LASER key switch and POWER switch to OFF position and start the system again.

1-2 Starting the Software



Turn on the microscope and power supply units before starting this software.

1. Enter the user name and password to log in the Windows.

FV10-ASW



FV10-ASW

[FLUOVUEW] icon



Log in using the user name given the Administrator's authority.

2. Double-click the [FLUOVUEW] icon on the desktop.



If more than one user uses the FV1000, each user should personally log in personally. For details, refer to Appendix E, "USER REGISTRATION OF FV1000" in Volume [OPERATION INSTRUCTIONS].



It takes 20 to 30 seconds after the [FLUOVUEW] icon is double-clicked till the software starts up.



Images cannot be observed if the manual shutter of the fluorescence mirror unit is close. In this case, slide the shutter to the open position.



When you lower the objective lens, please pay a careful attention so that the objective lens does not touch the specimen.

1-3 Exiting from the Software

Exit from the application software and shut down Windows.

NOTE

After exiting the application software, the light of mercury burner power supply unit may exposure to specimen. To avoid this, perform either of the followings,

- Close the manual shutter of the mercury burner power supply unit.
- Turn off the mercury burner power supply unit.
- Close the manual shutter of the fluorescence mirror unit (BX61WI or IX81).

1-4 Turning the Power Off

Set the power switches of the units to **O** (OFF).

When using of Multi-line Argon laser (FV5-LAMAR-2)

Turn the key to OFF position. Set the power switch to OFF.

When using of Multi-line Argon laser (FV5-LAMAR)

Turn the key to OFF position and wait for the fan to stop automatically when the laser unit has cooled down. It takes several minutes until the fan of laser stops. Set the power switch to OFF. (Also the power supply fan will stop automatically.)

(For details, refer to the instruction manual of laser units.)

In case of LD559 laser

Turn LASER key switch to OFF position and then, turn POWER switch to **O** – (OFF) position.

2 Replacement of Cubes

2-1 Replacing the DM Cube

The DM cube is used to connect the light path of the optional FV10-ASU Auxiliary Scan Unit or FV10-OPD Non-confocal Point Detector with that of the scan unit, and should be selected according to the observation method.

2-1-1 With the FV10-ASU

1. Set the light path of the scan unit to the LSM light path. (This can be done with the FLUOVIEW software. For details, refer to the User's Manual for the FLUOVIEW software.)
2. Loosen the four cover clamping knobs ① on the lower part of the right side panel of the scan unit, and remove the cover ②.

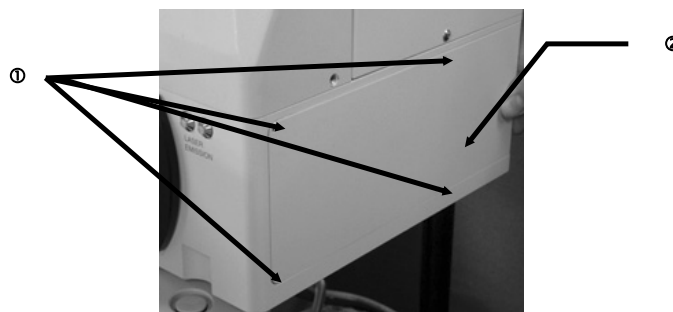

3. Using an Allen screwdriver, loosen the screw ④ retaining the guide lock plate ③, move the guide lock plate in the direction of the arrow, engage it with the pin ⑤ below the guide, and tighten the screw ④ again to lock the guide.

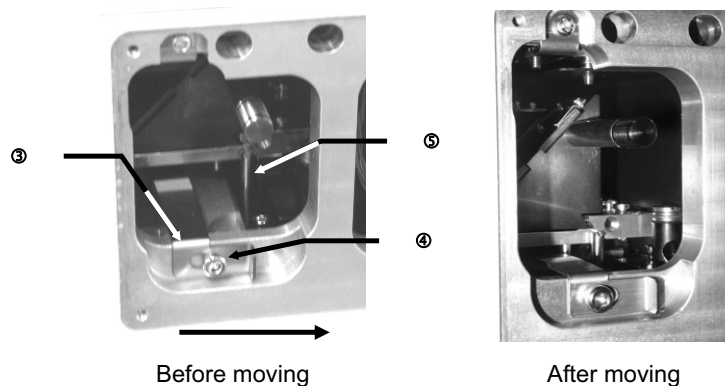

- Using the Allen screwdriver, loosen the clamping screw ⑥ retaining the DM cube.

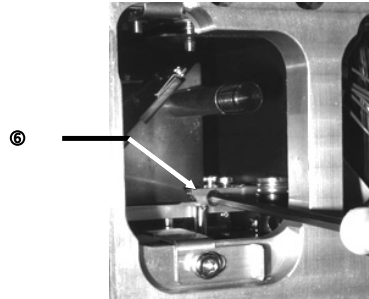

- Pull out the DM cube insertion knob ⑦ toward you and take out the DM cube from the light path selector mechanism.

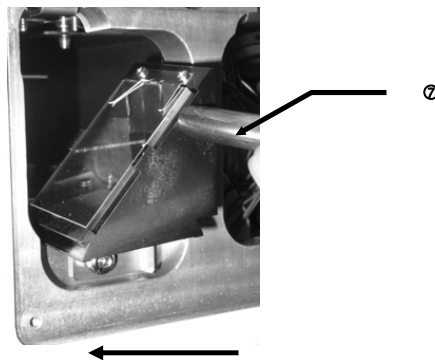

- Insert the desired DM cube in the dovetail of the light path selector mechanism, and tighten the clamping screw ⑥ using the Allen screwdriver.
- Loosen the screw ④ retaining the guide lock plate, slide it in the direction of the arrow and tighten the screw ④ again.
- Attach the scan unit cover to the original position.

TIP

To use DM replaced, it requires the following preparations.

- Log-in FV10-ASW software with the administrative right.
- Select [Tools] – [Maintenance] and bring [FV1000 Setup] window to appear.
- Click on <System Settings> button and select [Filter2] tab.
- From the drop down list located in [ASU DM] group box, select the DM that was replaced.
- Click on <Save and Close> button and close [FV1000 Setup] window.
- Re-boot FV10-ASW software.

2-1-2 With the FV10-OPD

1. Perform the same operations as steps 1 to 5 in section 2-1-1, "With the FV10-ASU" to take out the DM cube.
2. Using a precision Phillips screwdriver, loosen the screw clamping the DM holder plate and take out the DM and DM holder plate.

NOTE

The applicable DM (Dichroic Mirror) diameter is $26^{+0.1}_{-0.3} \times 38^{+0.1}_{-0.3} \text{ mm}$, with thickness of $1 \pm 0.05 \text{ mm}$.

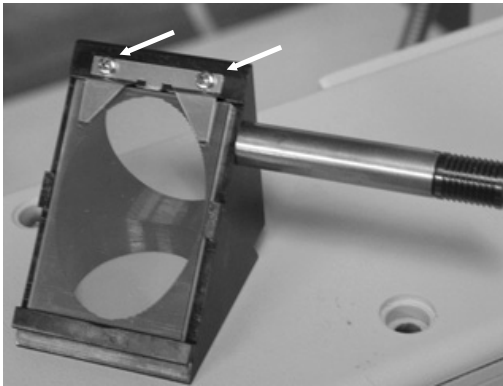

NOTE

The DM should be inserted by distinguishing the face and back. Make sure that the reflective surface (interference film surface) of the DM comes as the face.

3. Insert the desired DM and tighten the screw to clamp the DM holder plate.

2-2 Replacing the Spectral Cube

To improve the efficiency of fluorescence detection, the fluorescence waveform separating dichroic mirrors and barrier filters (2 channels) of the spectral cube inside the external photo-multiplier (FV10-OPD) can be replaced according to the excitation wavelength to be used.

2-2-1 Removing the spectral cube

1. Using an Allen screwdriver, loosen the two cover clamping screws (provided with slip-off prevention mechanisms) ① on the left side panel of the FV10-OPD and remove the cover ②.
2. Loosen the cube cover clamping screws ③ inside the cover in the same way as in step 1, and remove the cube cover by holding the cover knob ④.

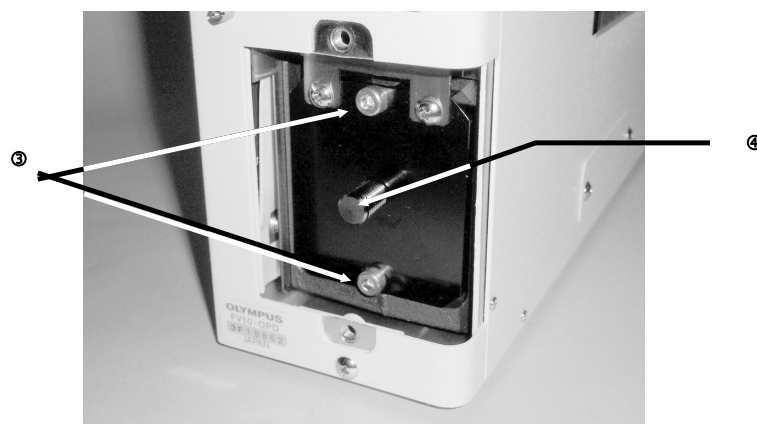
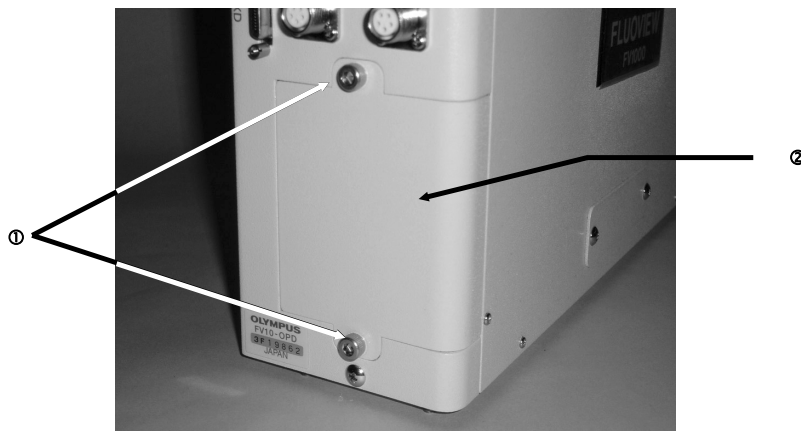

- Loosen the spectral cube clamping screw ⑤ a little using the Allen screwdriver, and pull out the spectral cube by holding the spectral cube insertion knob ⑥.

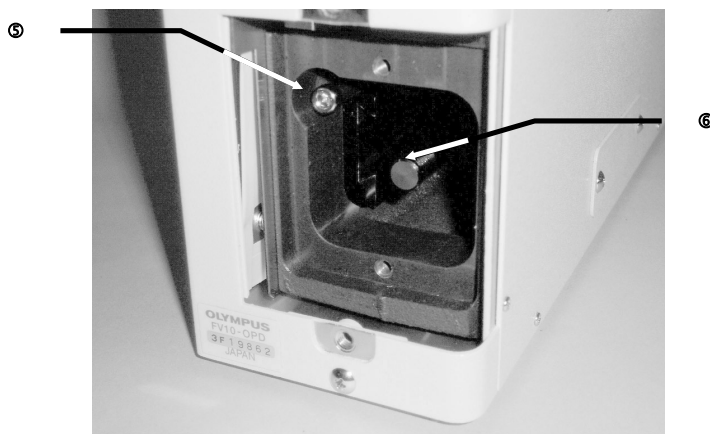

2-2-2 Fabricating a spectral cube

A desired spectral cube can be fabricated by attaching a commercially available barrier filter and DM to the spectral cube frame.

Dimensional conditions for the optical components

Barrier filter $\phi 25^{+0.1}_{-0.2} \text{ mm}$, max. thickness **6mm**

Dichroic mirror $26^{+0.1}_{-0.3} \times 38^{+0.1}_{-0.3} \text{ mm}$, thickness **$1 \pm 0.05 \text{ mm}$**

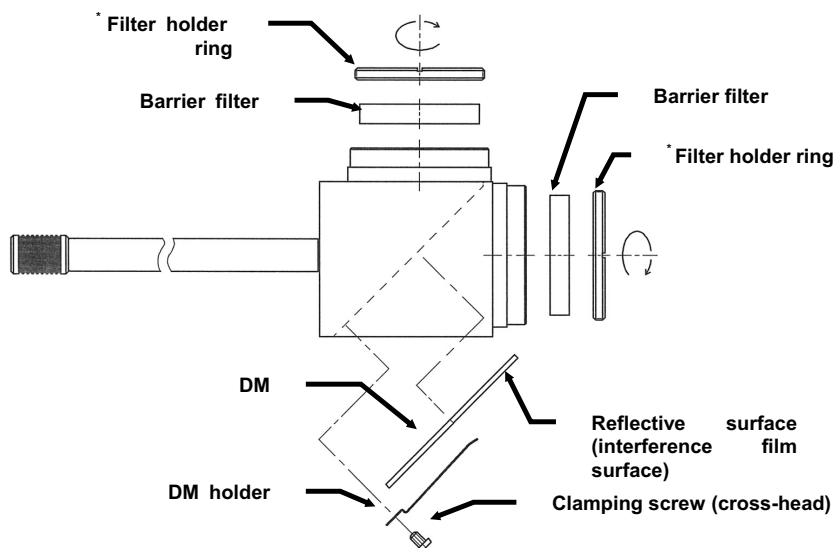



When replacing the DM and barrier filter, take special care not to contaminate them with fingerprints, etc.



*** Orientation of the filter holder ring**

Attach the filter holder ring by changing its orientation according to the filter thickness, insert the tip of a precision flat-blade screwdriver into the notch on the ring and turn the ring taking care not to scratch the filter to lock it.

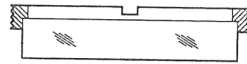

Filter thickness 4-6 mm



Filter thickness <4 mm

2-2-3 Attaching the spectral cube

Attach the spectral cube, together with the DMs and barrier filters, by reversing the removing procedure.



To use DM replaced, it requires the following preparations.

1. Log-in FV10-ASW software with the administrative right.
2. Select [Tools] – [Maintenance] and bring [FV1000 Setup] window to appear.
3. Click on <System Settings> button and select [Filter2] tab.
4. Verify that [Nonconfocal Detector] group box is set to “ FV10-OPD”.
5. Enter information of the spectral cube that was replaced in [Cube] drop down list, [Emission DM] text box, [BF CH1] text box and [BF CH2] text box respectively.
6. Click on <Save and Close> button and close [FV1000 Setup] window.
7. Re-boot FV10-ASW software.

3 Centration of Mercury Burner

For the reflected light fluorescence observation, refer to the User's Manual for the Reflected Light Fluorescence System.

Since this system introduces the light of a mercury burner through the light guide, the burner centering method is slightly different from that described in the User's Manual for the Reflected Light Fluorescence System. This section is intended to describe the method specific to this system.

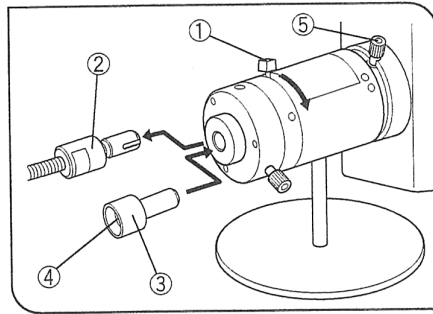

1. Turn the shutter ① fully toward the bottom to block the light.
When the light guide is disconnected, another built-in shutter is engaged automatically in the light path to ensure safety.
2. Remove the light guide ② from the ULH holder and replace with the centering target ③.
3. Turn the shutter ① toward the open direction. The arc image of the mercury burner will be visible on the screen ④ of the centering target ③.

TIP

The arc image stabilizes in 5 to 10 minutes after the mercury burner is turned on.

NOTE

Keep the shutter ① closed except for centering operation to prevent the centering target from being heated up.

Centration of Mercury Burner



4. Turn the collector lens focusing knob ⑤ on the lamp housing to bring the arc image into focus.

TIP

Hereafter, centering is possible with the method described in the User's Manual for the Reflected Fluorescence System, that is, using the burner centering knob and mirror focusing screw.

5. After completing centering, remove the centering target and connect the light guide. When starting observation, turn the collector lens focusing knob ⑤ to maximize the brightness of the observation field.

TIP

The mercury burner does not have to be centered until the next time it is replaced.

4 Replacement of Lamps

4-1 The Bulb

TIP

Use only the designated bulb 12V100WHAL-L (PHILIPS 7724) or 12V50WHAL-L (LIFE JC).

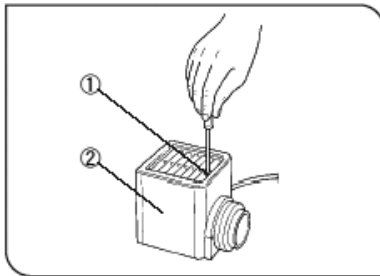

Fig. 3

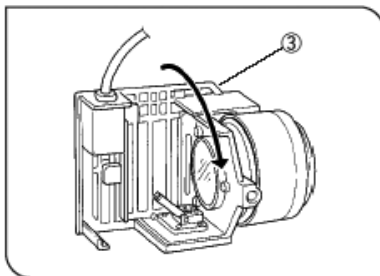

Fig. 3

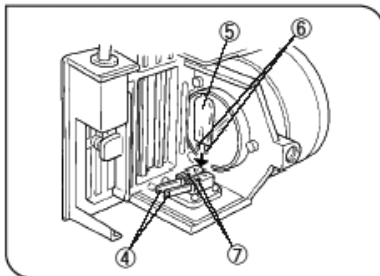
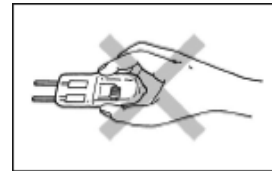

Fig. 3

1. Fully loosen the lamp housing clamping screw (1) on to of the lamp housing cover with the provided Allen screwdriver.
2. Lift the lamp housing cover (2) upward to remove it.
3. Turn the lamp socket (3) by 90° in the direction indicated by the arrow.
4. Holding the bulb (5) with gloves or a piece of gauze, depress the bulb clamping lever (4) and insert the bulb pins (6) fully into the pin holes (7) on the lamp socket. Gently release the bulb clamping lever to the original position to secure the bulb.



To prevent reduced bulb life or cracking, do not touch the bulb with bare hands. If fingerprints are accidentally left on the bulb, wipe the bulb with a soft cloth.

5. Side the lamp housing cover onto the housing base from the above. Tighten the clamping screw (1) while pressing downward on the cover.

Caution for Bulb Replacement During Use or Right After Use

The bulb and the lamp socket are areas near these will be extremely hot during and right after use.

Set the main switch to “○” (OFF), disconnect the power cord from the wall outlet, then allow the old bulb and lamp housing to cool before replacing the bulb with a new of the designated type.

4-2 The Mercury Burner

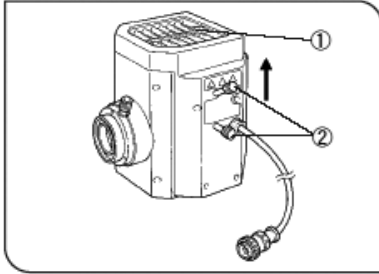

Fig. 5

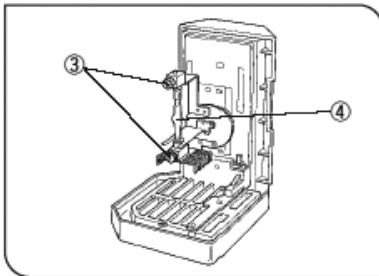

Fig. 5

1. Loosen the socket clamping screw (1) using the Allen screwdriver.
2. Hold the upper section of lamp housing and pull it upward to remove the socket section.

NOTE

To prevent malfunctions, do not hold the lamp housing by the centering knobs (2).

3. Place the socket section upside down as shown in Fig. 5.

TIP

The lamp housing is equipped with the holder for transportation in the factory shipment condition, or with an old burner when the burner is replaced. Remove the holder or old burner by loosening the two burner holding screws (3).

4. Attach the + (positive) pole of a specified mercury burner | to the fixed mount on the upper side, and the - (negative) pole to the mount on the lower side.

NOTE

Be sure to use the USH-103OL (mfd. by OLYMPUS) or HBO103W/2 (mfd. by OSRAM) burner.



Be careful and avoid leaving fingerprints or contaminants on the mercury burner. Otherwise, there is a danger of explosion due to distortion of glass caused by the stains. If the burner is contaminated, clean it by wiping gently with gauze slightly moistened with absolute alcohol.



5. Attach the socket section with burner to the original position and tighten the clamping screw (1).



Align the external edges of the lamp housing with those on the socket section, and push the lamp housing straight downward.

Burner Service Life

USH-103OL: 300 hours



This value assumes light cycles composed of 2 hours of lighting and 30 minutes of extinction. Do not turn it on and off at a shorter cycle than the above, for this will shorten the service life of the burner.



After replacing the burner, reset the hour counter to “0.0” as outlined above.

III. TROUBLE Q&A

On This Volume

This volume describes how to deal with troubles with the FLUOVIEW FV1000 system.

If any irregularity is observed, read this volume before calling for service. If the irregularity cannot be resolved by the described remedial action, please contact Olympus for repair.

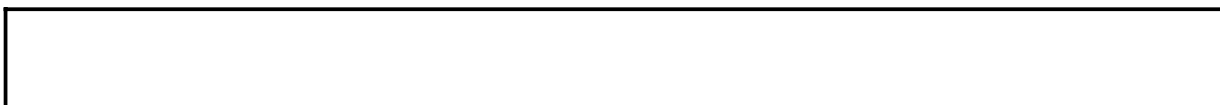

1 Troubleshooting Guide **1-1**

1. Laser is not output from the extremity of the objective..... 1-1
2. Fluorescence image cannot be observed. 1-1
3. Transmitted image cannot be observed..... 1-2
4. Image is disturbed. 1-2
5. Reflected light (laser light) enters the fluorescence image..... 1-2
6. Fluorescence image is poor. 1-2
7. Fluorescence image is dark and noisy..... 1-2
8. Image is irregularly blurred or the brightness is uneven. 1-3
9. Observed image is out of focus. 1-3
10. The intensity of part of the wavelength region of the spectral
characteristic data of fluorescence is dropped. 1-3
11. Flare is observed. 1-3
12. Visual fluorescent light observation is impossible..... 1-3
13. The light from the laser for the ASU (additional scan unit) is not
output. 1-4

1 Troubleshooting Guide

The system may be unable to manifest its full performance due to its usage as well as malfunction. In case a problem occurs with the system please check the following list to find appropriate countermeasures.

If the problem cannot be resolved by the described remedial action, please contact Olympus for repair.

Irregularity	Cause	Remedy
1. Laser is not output from the extremity of the objective.	The laser unit is not turned ON.	Turn on the laser unit. Make sure that the emission key is set to ON.
	The laser wavelength is not selected.	Check the laser wavelength to be used.
	The manual shutter of the fluorescence mirror unit is closed. (Manual system only)	Open the manual shutter.
	The reflective mirror inside the fluorescence mirror unit is not in the light path. (Manual system only)	Engage the reflective mirror in the light path.
	The objective is not in the light path.	Engage the desired objective in the light path. When using a manual revolving nosepiece, be sure to stop the objective in the click position.
	The laser beam is too weak.	Increase the laser intensity.
	The properties of the combined cube unit used for the ASU (auxiliary scan unit) or OPD (non-confocal point detector) do not match the selected laser wavelength.	Engage a DM cube unit matching the selected laser wavelength in the light path.
2. Fluorescence image cannot be observed.	The confocal pinhole diameter is too small.	Increase the pinhole diameter.
	The excitation Dichroic Mirror selection does not match the observed fluorescence wavelength and excitation laser wavelength.	Engage a DM optimum for the observed fluorescence and excitation laser wavelengths.
	The spectral dichroic mirror and barrier filter selections do not match the observed fluorescence wavelength.	Engage a spectral DM and barrier filter matching the observed fluorescence in the light path.
	The acquisition wavelength region setting is not suitable for the observed fluorescence wavelength. (Spectral detection system only)	Set an acquisition wavelength region matching the observed fluorescence.
	The fluorescent dyeing method and excitation wavelength do not match each other.	Select a laser optimum for the fluorescent dyeing method.
	Focus is not adjusted.	Adjust the focus.
	The PMT voltage of the detector is too low.	Increase the PMT voltage.

Troubleshooting Guide

--

Irregularity	Cause	Remedy
2. Fluorescence image cannot be observed.	The offset value is too large.	Decrease the offset value.
	The detector for the channel to be detected is not selected.	Select the detector.
3. Transmitted image cannot be observed.	The transmitted light detection channel is not selected.	Select the transmitted light detection channel.
	The transmitted light filter for the microscope is in the light path.	Disengage the filter from the light path.
	The PMT voltage of the transmitted light detection channel is too low.	Increase the PMT voltage.
	The offset value for the transmitted light detection channel is too large.	Decrease the offset value.
4. Image is disturbed.	The system installation location is subject to excessive vibrations.	Contact Olympus.
	Extraneous light such as the light of a fluorescent lamp is detected.	Turn the room light low before acquiring image.
5. Reflected light (laser light) enters the fluorescence image.	The barrier filter is set erroneously or absent.	Engage a barrier filter that can cut the excitation laser wavelength in the light path.
	The set acquisition wavelength is overlapped with or too close to the excitation laser wavelength. (Spectral detection system only)	Select an acquisition wavelength that is not interfered with by the laser wavelength. (Note that, when the confocal pinhole is large and the BS20/80 excitation DM is used, penetration of laser light may become large.)
	The barrier filter that can cut the wavelength of the laser light irradiated from the ASU (auxiliary scan unit) is not selected. In the case of a spectral detection system, the acquisition wavelength setting may be inappropriate.	Engage a barrier filter that can cut the laser wavelength from the ASU in the light path. With a spectral detection system, change the acquisition wavelength setting.
6. Fluorescence image is poor.	The front lens of the objective is dirty.	Clean the objective front lens by wiping it with a piece of gauze.
	When an objective with correction collar is in use, the correction collar is adjusted improperly.	Adjust the correction collar properly.
	The cover glass thickness is inappropriate.	Use a cover glass with thickness of 0.17 mm.
7. Fluorescence image is dark and noisy.	The laser beam is too weak.	Increase the laser intensity.
	The fluorescent dyeing method and excitation wavelength do not match each other.	Select a laser optimum for the fluorescent dyeing method.

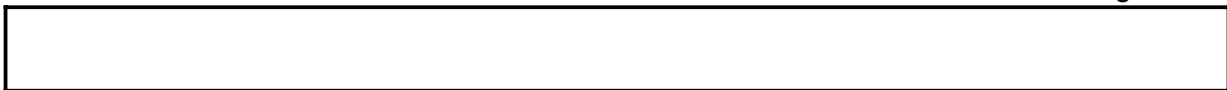

Irregularity	Cause	Remedy
7. Fluorescence image is dark and noisy.	The excitation Dichroic Mirror selection does not match the observed fluorescence wavelength and excitation laser wavelength.	Engage a DM optimum for the observed fluorescence and excitation laser wavelengths.
	The spectral dichroic mirror and barrier filter selections do not match the observed fluorescence wavelength.	Engage a spectral DM and barrier filter matching the observed fluorescence in the light path.
	The acquisition wavelength region setting is not suitable for the observed fluorescence wavelength. (Spectral detection system only)	Set an acquisition wavelength region matching the observed fluorescence.
	The confocal pinhole diameter is too small.	Increase the pinhole diameter.
	The scanning rate is too high.	Decrease the scanning rate.
	The HV setting is too high.	Decrease the HV and increase the gain. An alternative remedy is to decrease the scanning rate and decrease the HV.
	The width of the acquisition wavelength region is too small.	Increase the width of the acquisition wavelength region.
	Dyeing is too pale.	Perform optimum fluorescent dyeing.
8. Image is irregularly blurred or the brightness is uneven.	The specimen or stage is tilted.	Install the specimen and stage properly.
9. Observed image is out of focus.	The focus is adjusted improperly.	Adjust the focus in visual observation.
10. The intensity of part of the wavelength region of the spectral characteristic data of fluorescence is dropped.	The spectral characteristics of the fluorescence are affected by those of the excitation dichroic mirror used in double excitation.	Use an excitation DM that does not affect the spectral characteristic data of fluorescence.
11. Flare is observed.	The glass in use is not fluorescence-free glass.	Use fluorescence-free glass.
	The specimen is overstained.	Perform optimum dyeing again or increase the offset value.
12. Visual fluorescent light observation is impossible.	The light path selector in the SU is not set for the visual observation light path.	Select the visual observation light path.
	The shutter for the mercury burner is closed.	Open the shutter for the mercury burner.
	The mirror unit incorporating a dichroic mirror is not present in the turret of the illuminator.	Engage a mirror unit containing DM in the light path.

Troubleshooting Guide

--

Irregularity	Cause	Remedy
13. The light from the laser for the ASU (additional scan unit) is not output.	The properties of the combined DM cube unit for ASU do not match the irradiated laser wavelength.	Engage a DM cube unit matching the laser wavelength in the light path.
	The combined DM cube unit for ASU is not in the light path.	Engage the DM cube unit in the light path.



OLYMPUS CORPORATION

Shinjuku Monolith, 3-1, Nishi Shinjuku 2-chome, Shinjuku-ku, Tokyo, Japan

OLYMPUS EUROPA HOLDING GMBH

Wendenstrasse 14-18, 20097 Hamburg, Germany

OLYMPUS AMERICA INC.

3500 Corporate Parkway, Center Valley, Pennsylvania 18034-0610, U.S.A.

OLYMPUS SINGAPORE PTE LTD.

491B River Valley Road #12-01/04 Valley Point Office Tower, Singapore 248373

OLYMPUS AUSTRALIA PTY. LTD.

31 Gilby Road, Mount Waverley, VIC., 3149, Melbourne, Australia

OLYMPUS LATIN AMERICA, INC.

5301 Blue Lagoon Drive, Suite 290 Miami, FL 33126, U.S.A.

